

**a-Si TFT LCD Single Chip Driver
320RGBx240 Resolution and 16.7M color**

Datasheet
Preliminary

Version: Preliminary V1.12
Document No.: ILI9322DS_V1.12.pdf

ILI TECHNOLOGY CORP.

4F, No. 2, Tech. 5th Rd., Hsinchu Science Park,
Taiwan 300, R.O.C.
Tel.886-3-5670095; Fax.886-3-5670096
<http://www.ilitek.com>

Table of Contents

Section	Page
1. Introduction	4
2. Features.....	4
3. Block Diagram	6
4. Pin Descriptions.....	7
5. Pad Arrangement and Coordination	10
6. System Interface.....	19
6.1. Input Interfaces	19
6.1.1. ITU-R BT.601 Interface	19
6.1.2. ITU-R BT.656 Interface	21
6.1.3. 8-bit Serial RGB Interface	23
6.1.4. 8-bit Serial RGB Dummy Interface.....	25
6.1.5. 24-bit Parallel RGB Interface	28
6.2. Serial Peripheral Interface (SPI).....	29
7. Register	30
7.1. Register Description.....	31
7.1.1. Device ID (R00h).....	31
7.1.2. VCOM AC Voltage (R01h).....	31
7.1.3. VCOM High Voltage (R02h).....	31
7.1.4. VREG1OUT Voltage (R03h).....	32
7.1.5. Global Reset (R04h)	32
7.1.6. Power Setting 1 (R05h).....	33
7.1.7. Entry Control (R06h)	33
7.1.8. Power Control (R07h)	35
7.1.9. Back Porch Control (R08h, R09h).....	36
7.1.10. Polarity Control (R0Ah)	36
7.1.11. Interface Control (R0Bh)	37
7.1.12. Power Control 1 (R0Ch).....	38
7.1.13. Power Control 2(R0Dh).....	38
7.1.14. Contrast Control (R0Eh).....	39
7.1.15. Brightness Control (R0Fh)	39
7.1.16. Power Control 2 (R30h)	39
7.1.17. OTP Programming Data (R42h).....	41
7.1.18. OTP Program Read Back Register (R43h).....	41
7.1.19. OTP Programming ID Key (R44h)	41
8. Color Filter Arrangement (CFA).....	43
9. Gamma Correction	45
10. Power Sequence	57

10.1. Power ON Sequence	57
10.2. Power OFF Sequence	59
10.3. Standby Sequence	60
11. Electrical Characteristics.....	61
11.1. Absolute Maximum Ratings	61
11.2. DC Electrical Characteristics	61
12. Revision History.....	62

Figures

FIGURE1 ITR-R BT.601 VERTICAL INPUT SIGNAL	19
FIGURE2 ITR-R BT.601 HORIZONTAL INPUT SIGNAL	19
FIGURE3 ITR-R BT.656 INPUT SIGNAL	21
FIGURE4 SERIAL RGB INPUT SIGNAL TIMING	23
FIGURE5 8-BIT SERIAL RGB DUMMY INPUT SIGNAL TIMING.....	25
FIGURE6 PARALLEL RGB INPUT SIGNAL TIMING.....	28
FIGURE7 SPI INTERFACE INPUT SIGNAL TIMING	29
FIGURE8 POWER ON SEQUENCE	57
FIGURE9 POWER ON SEQUENCE FLOW CHART.....	58
FIGURE 10 POWER OFF SEQUENCE FLOW CHART.....	59
FIGURE11 POWER OFF SEQUENCE FLOW CHART.....	59
FIGURE12 STANDBY ON/OFF SEQUENCE.....	60
FIGURE13 STANDBY ON/OFF FLOW CHART	60

1. Introduction

ILI9322 is a one-chip SoC driver for a-TFT liquid crystal display with resolution of 320RGBx240 dots, which can handle 256 (8-bit) gray scale levels for each color and drive versatile panels with max. 320RGBx240 dots resolution and delta or strip color filter array (CFA). The source driver, timing controller, DC/DC charge-pump, regulator, level shifter, and gamma correction circuits for R, G, B are also integrated in ILI9322, which generates all control signals to drive a-TFT panels.

ILI9322 has four kinds of system interfaces for display data transfers, which are 8-bit serial RGB interface, 24-bit parallel RGB interface, ITU-R BT.601 interface and ITU-R BT.656 interface. The SPI interface is used to access the internal registers and control the function of ILI9322.

The internal power supply circuit is implemented to provide all the necessary power levels of source, gate, gamma, I/O and internal digital circuit.

The ILI9322 supports power saving operation with single input power to generate voltage to drive liquid crystal. The ILI9322 also supports versatile input interfaces of various digital video standards to make ILI9322 the ideal solution for any medium or small sized portable battery-driven products such as the digital still camera, digital camcorder, and media player applications where long battery life and board size are major concern.

2. Features

- ◆ Single chip solution for landscape QVGA a-TFT LCD display driver
- ◆ Incorporate 960-channel source driver and 240-channel gate driver
- ◆ 320RGBx240-dot resolution capable with real 16.7M display color
- ◆ System interfaces
 - 8-bit serial RGB interface
 - 24-bit parallel RGB interface
 - 8-bit ITU-R BT.601
 - 8-bit ITU-R BT.656 with embedded syncs
 - 3-wire serial interface (SPI) for registers configuration: CSB, SCL, SDA, SDO
- ◆ Support NTSC/PAL TV system
- ◆ Line/Frame inversion is supported
- ◆ Reversible Up/Down and Left/Right display direction
- ◆ Built-in power supply circuit for all the power levels
- ◆ Incorporate step-up circuits for stepping up a liquid crystal drive voltage level up to 6 times (x6)
- ◆ Booster circuit is implemented to provide all the voltage for LCD display
- ◆ Low -power consumption architecture
 - standby mode
 - Low operating power supplies:
 - IOVcc = 1.65 ~ 3.6 V (interface I/O)

- Vcc = 2.7 ~ 3.6 V (internal logic)
- Vci = 2.7 ~ 3.6V (analog)
- LCD Voltage Drive: VREG1OUT - AGND = 4.0 ~5.5V

3. Block Diagram

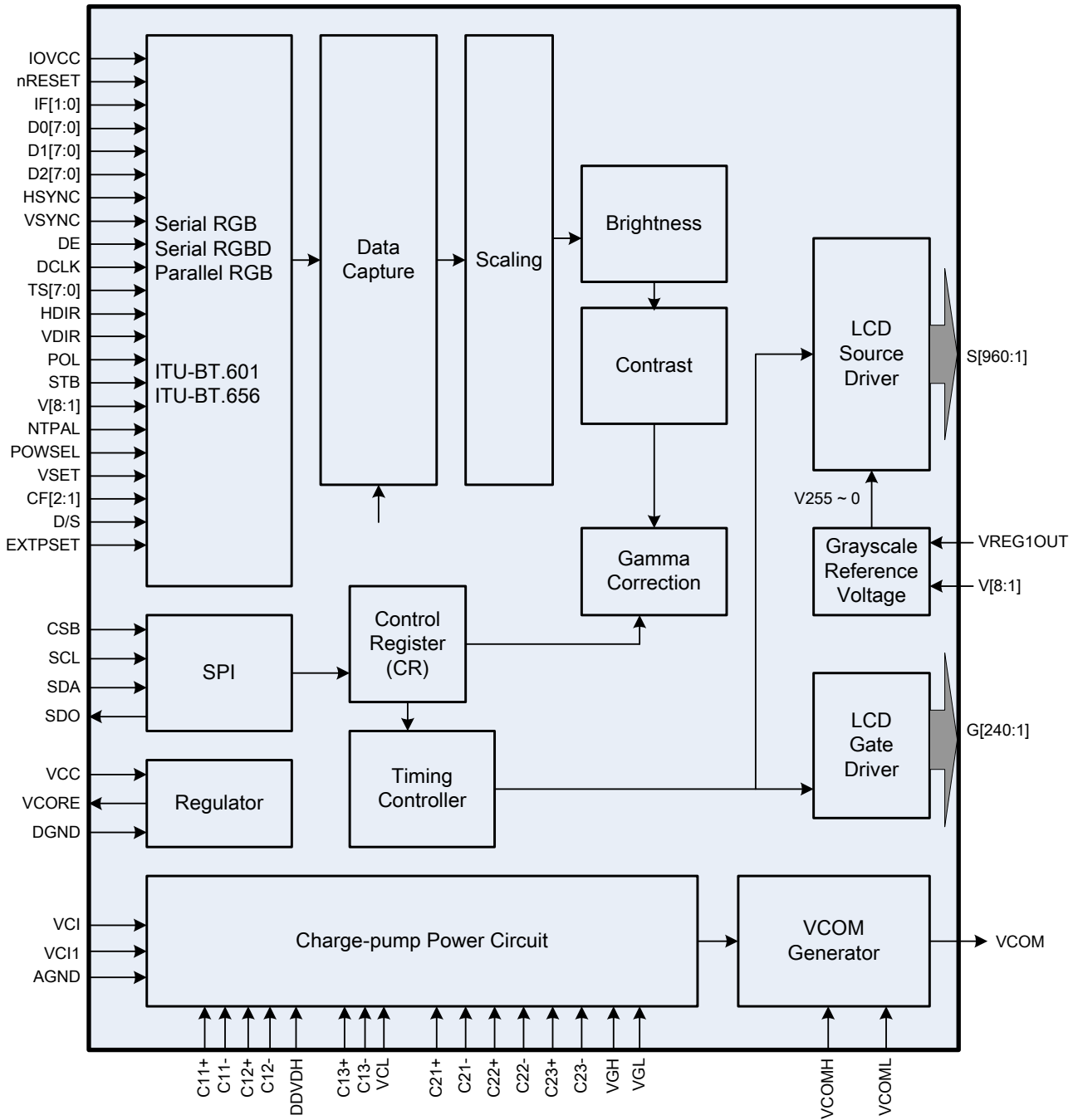

4. Pin Descriptions

Pin Name	I/O	Type	Descriptions															
Input Interface																		
IF2, IF1	I	IOVcc	System interface selection pins															
			<table border="1"> <thead> <tr> <th>IF2</th> <th>IF1</th> <th>Interface Mode Selection</th> </tr> </thead> <tbody> <tr> <td>0</td> <td>0</td> <td>8-bit Serial RGB Interface</td> </tr> <tr> <td>0</td> <td>1</td> <td>24-bit Parallel RGB Interface</td> </tr> <tr> <td>1</td> <td>0</td> <td>ITU-R BT.601</td> </tr> <tr> <td>1</td> <td>1</td> <td>ITU-R BT.656</td> </tr> </tbody> </table>	IF2	IF1	Interface Mode Selection	0	0	8-bit Serial RGB Interface	0	1	24-bit Parallel RGB Interface	1	0	ITU-R BT.601	1	1	ITU-R BT.656
			IF2	IF1	Interface Mode Selection													
			0	0	8-bit Serial RGB Interface													
			0	1	24-bit Parallel RGB Interface													
1	0	ITU-R BT.601																
1	1	ITU-R BT.656																
DCLK	I	IOVcc	Clock signal The input data is latched on the rising edge of CLK.															
D0[7:0] D1[7:0] D2[7:0]	I	IOVcc	Digital data input Dx7 is the MSB and Dx0 is LSB. When the serial RGB interface or ITU-R BT601/656 input interface is selected, the D0[7:0] data bus are used, and the other pins are not used. Fix unused pins to GND level when not in use.															
VSYNC	I	IOVcc	Vertical synchronizing input signal When the ITU-R BT656 input interface is selected, this pin is unused and short VSYNC pin to GND.															
HSYNC	I	IOVcc	Horizontal synchronizing input signal When the ITU-R BT656 input interface is selected, this pin is unused and short HSYNC pin to GND.															
DE	I	IOVcc	Input data enable signal VSYNC+HSYNC mode: This pin is shorted to GND normally and the back/front porch is determined by the control register.															
			VSYNC+HSYNC+DE mode: The valid data is determined by the VSYNC+HSYNC+DE pin.															
			DE mode: VSYNC and HSYNC are unused and shorted to GND. The valid input data is determined by DE pin. Fix DE to GND level when not in use.															
HDIR	I	IOVcc	Data Shift direction When HDIR =L, OUT960 → OUT959 → → OUT1 When HDIR =H, OUT1 → OUT2 → → OUT960 Fix HDIR to GND level when not in use.															
VDIR	I	IOVcc	Scan direction selection When VDIR=L, scan direction is from bottom to top (reverse scan) When VDIR=H, scan direction is from top to bottom (normal scan) Fix VDIR to GND level when not in use.															
POL	O	IOVcc	Polarity output signal When POL=L, output voltage is negative polarity. When POL=H, output voltage is positive polarity. Let POL as floating when not used.															
STB	I	IOVcc	Operation mode selection STB=L, ILI9322 enters the standby mode and all outputs stop. STB=H, ILI9322 enters normal operation mode. Fix STB to GND level when not in use.															
POWSEL	I	IOVcc	Internal/external power selection When POWSEL =H, the external power supply is applied (internal charge-pump stops). When POWSEL =L, internal charge-pump is enabled.															
NTPAL	O	IOVcc	NTSC or PAL mode auto detection result When NTPAL=H, NTSC input signal is detected.															

Pin Name	I/O	Type	Descriptions
			When NTPAL=L, PAL input signal is detected. Let NTPAL as floating when not used.
VSET	I	IOVcc	Gamma correction internal/external voltage selection When VSET=L, internal gamma correction voltage selected. When VSET=H, external gamma correction voltage selected.
VGS	I	VREG1OUT	Gamma correction adjustment input. This pin is tied to GND for normal operation.
V1 ~ V8	I	VREG1OUT	Gamma correction adjustment input voltage Let V1~V8 as floating when not used.
CF[2:1]	I	IOVcc	Select the delta type color filter arrangement
D/S	I	IOVcc	Color filter type selection When D/S =H, stripe CF type When D/S =L, delta CF type
EXTPSET	I	IOVcc	External pin control signal EXTPSET = H, Using the register to control the HDIR, VDIR and STB. EXTPSET = L, Using the I/O pin control the HDIR, VDIR and STB.
nRESET	I	IOVcc	A reset pin. Initializes the ILI9322 with a low input. Be sure to execute a power-on reset after supplying power.
CSB	I	IOVcc	A chip select signal. CSB = L: the ILI9322 is selected and accessible CSB = H: the ILI9322 is not selected and not accessible Fix CSB to the IOVCC level when not in use.
SCL	I	IOVcc	SPI clock signal. Fix SCL to GND level when not in use.
SDA	I	IOVcc	SPI interface input pin. The data is latched on the rising edge of the SCL signal. Fix SDA to GND level when not in use.
SDO	O	IOVcc	SPI interface output pin. The data is outputted on the falling edge of the SCL signal. Let SDO as floating when not used.
LCD Driving signals			
S[960:1]	O	VREG1OUT	Source driver outputs
G[240:1]	I	VREG1OUT	Gate driver outputs
VCOM	O	TFT common electrode	A supply voltage to the common electrode of TFT panel. VCOM is AC voltage alternating signal between the VCOMH and VCOML levels.
VCOMH	O	Stabilizing capacitor	The high level of VCOM AC voltage. Connect to a stabilizing capacitor.
VCOML	O	Stabilizing capacitor	The low level of VCOM AC voltage. Adjust the VCOML level with the VDV bits. Connect to a stabilizing capacitor. To fix the VCOML level to AGND and set VCL_EN = "0". In this case, capacitor connection is not necessary.
Charge-pump and Regulator Circuit			
VCC	I	Power	Digital power supply VCC = 2.7V ~ 3.6V
Vcore	O	Stabilizing capacitor	Digital power (internal generation) Vcore= 1.8V
GND	I	Power	Digital ground
IOVcc	I	Power	Interface power supply IOVCC= 1.65V ~ 3.6V
VCI	I	Power supply	A supply voltage to the analog circuit. Connect to an external power supply of 2.7V ~ 3.6V.
VCI1	I	Stabilizing capacitor	Regulated voltage VCI1 is regulated from VCI.
AGND	I	Power supply	AGND for the analog side: AGND = 0V. In case of COG, connect to GND on the FPC to prevent noise.

Pin Name	I/O	Type	Descriptions
DDVDH	O	Stabilizing capacitor	Output voltage from the step-up circuit 1, which is generated from VCI1. Place a stabilizing capacitor between AGND.
VREG1OUT	O	Stabilizing capacitor	Output voltage from the step-up circuit 1. The step-up factor is set by "BT" bits. VREG1OUT= 4.0 ~6.0V Place a stabilizing capacitor between AGND.
VGH	I	Stabilizing capacitor	Power supply for the gate driver.
VGL	I	Stabilizing capacitor	Power supply for the gate driver.
VCL	O	Stabilizing capacitor	VcomL driver power supply. VCLC = 0 ~ -3.0V. Place a stabilizing capacitor between AGND
C11+, C11- C12+, C12-	I/O	Step-up capacitor	Capacitor connection pins for the step-up circuit DDVDH
C13+, C13-	I/O	Step-up capacitor	Capacitor connection pins for the step-up circuit VCL
C21+, C21- C22+, C22- C23+, C23-	I/O	Step-up capacitor	Capacitor connection pins for the step-up circuit VGH/VGL.
Test Pads			
TS[7:0]	I	IOVcc	Test pin. Leave these pin as floating
DUMMY	-	IOVcc	Test pin. Leave these pin as floating
NC	-	IOVcc	Test pin. Leave these pin as floating

Liquid crystal power supply specifications Table 1

No.	Item	Description	
1	TFT Source Driver	960 pins (320 x RGB)	
2	TFT Gate Driver	240 pins	
3	TFT Display's Capacitor Structure	Cst structure only (Common VCOM)	
4	Liquid Crystal Drive Output	S[960:1]	V0 ~ V255 grayscales
		G[240:1]	VGH - VGL
		VCOM	VCOMH - VCOML: Amplitude
5	Input Voltage	IOVcc	1.65 ~ 3.6V
		Vcc	2.7V ~ 3.6V
		VCI	2.7V ~ 3.6V
6	Liquid Crystal Drive Voltages	DDVDH	4.5V ~ 6.0V
		VREG1OUT	4.0V ~ 5.5V
		VGH	10V ~ 18V
		VGL	-9V ~ -15V
		VCL	0V ~ -3.0V
		VGH - VGL	Max. 32V
		VCI - VCL	Max. 6.0V
7	Internal Step-up Circuits	DDVDH	VCI1 x2
		VGH	VCI1 x4, x5, x6
		VGL	VCI1 x-3, x-4, x-5
		VCL	VCI1 x-1

5. Pad Arrangement and Coordination

Chip Size: 22092um x 712um

Chip thickness : 400 um (typ.)

Pad Location: Pad Center.

Coordinate Origin: Chip center

Au bump height: 15±3um.

Au Bump Size:

1. 18um x 100um
Gate: G1 ~ G240
Source: S1 ~ S960
2. 40um x 80um
Input Pads

Alignment Mark:

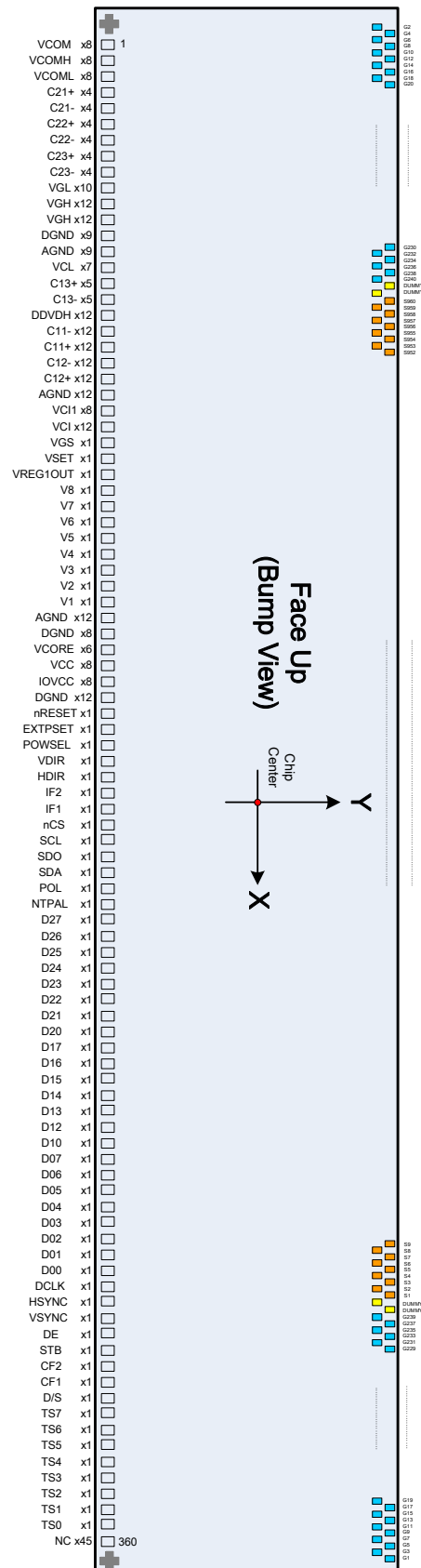
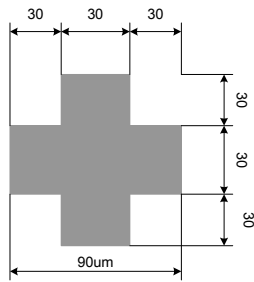

No.	Name	X	Y	No.	Name	X	Y	No.	Name	X	Y	No.	Name	X	Y	No.	Name	X	Y
1	VCOM	-10770	-266	51	VGL	-7770	-266	101	C13-	-4770	-266	151	C12-	-1770	-266	201	V8	1230	-266
2	VCOM	-10710	-266	52	VGL	-7710	-266	102	C13-	-4710	-266	152	C12-	-1710	-266	202	V7	1290	-266
3	VCOM	-10650	-266	53	VGL	-7650	-266	103	C13-	-4650	-266	153	C12-	-1650	-266	203	V6	1350	-266
4	VCOM	-10590	-266	54	VGL	-7590	-266	104	C13-	-4590	-266	154	C12+	-1590	-266	204	V5	1410	-266
5	VCOM	-10530	-266	55	VGL	-7530	-266	105	C13-	-4530	-266	155	C12+	-1530	-266	205	V4	1470	-266
6	VCOM	-10470	-266	56	VGL	-7470	-266	106	DDVDH	-4470	-266	156	C12+	-1470	-266	206	V3	1530	-266
7	VCOM	-10410	-266	57	VGL	-7410	-266	107	DDVDH	-4410	-266	157	C12+	-1410	-266	207	V2	1590	-266
8	VCOM	-10350	-266	58	VGL	-7350	-266	108	DDVDH	-4350	-266	158	C12+	-1350	-266	208	V1	1650	-266
9	VCOMH	-10290	-266	59	VGH	-7290	-266	109	DDVDH	-4290	-266	159	C12+	-1290	-266	209	AGND	1710	-266
10	VCOMH	-10230	-266	60	VGH	-7230	-266	110	DDVDH	-4230	-266	160	C12+	-1230	-266	210	AGND	1770	-266
11	VCOMH	-10170	-266	61	VGH	-7170	-266	111	DDVDH	-4170	-266	161	C12+	-1170	-266	211	AGND	1830	-266
12	VCOMH	-10110	-266	62	VGH	-7110	-266	112	DDVDH	-4110	-266	162	C12+	-1110	-266	212	AGND	1890	-266
13	VCOMH	-10050	-266	63	VGH	-7050	-266	113	DDVDH	-4050	-266	163	C12+	-1050	-266	213	AGND	1950	-266
14	VCOMH	-9990	-266	64	VGH	-6990	-266	114	DDVDH	-3990	-266	164	C12+	-990	-266	214	AGND	2010	-266
15	VCOMH	-9930	-266	65	VGH	-6930	-266	115	DDVDH	-3930	-266	165	C12+	-930	-266	215	AGND	2070	-266
16	VCOMH	-9870	-266	66	VGH	-6870	-266	116	DDVDH	-3870	-266	166	AGND	-870	-266	216	AGND	2130	-266
17	VCOML	-9810	-266	67	VGH	-6810	-266	117	DDVDH	-3810	-266	167	AGND	-810	-266	217	AGND	2190	-266
18	VCOML	-9750	-266	68	VGH	-6750	-266	118	C11-	-3750	-266	168	AGND	-750	-266	218	AGND	2250	-266
19	VCOML	-9690	-266	69	VGH	-6690	-266	119	C11-	-3690	-266	169	AGND	-690	-266	219	AGND	2310	-266
20	VCOML	-9630	-266	70	VGH	-6630	-266	120	C11-	-3630	-266	170	AGND	-630	-266	220	AGND	2370	-266
21	VCOML	-9570	-266	71	DGND	-6570	-266	121	C11-	-3570	-266	171	AGND	-570	-266	221	DGND	2430	-266
22	VCOML	-9510	-266	72	DGND	-6510	-266	122	C11-	-3510	-266	172	AGND	-510	-266	222	DGND	2490	-266
23	VCOML	-9450	-266	73	DGND	-6450	-266	123	C11-	-3450	-266	173	AGND	-450	-266	223	DGND	2550	-266
24	VCOML	-9390	-266	74	DGND	-6390	-266	124	C11-	-3390	-266	174	AGND	-390	-266	224	DGND	2610	-266
25	C21+	-9330	-266	75	DGND	-6330	-266	125	C11-	-3330	-266	175	AGND	-330	-266	225	DGND	2670	-266
26	C21+	-9270	-266	76	DGND	-6270	-266	126	C11-	-3270	-266	176	AGND	-270	-266	226	DGND	2730	-266
27	C21+	-9210	-266	77	DGND	-6210	-266	127	C11-	-3210	-266	177	AGND	-210	-266	227	DGND	2790	-266
28	C21+	-9150	-266	78	DGND	-6150	-266	128	C11-	-3150	-266	178	VCI1	-150	-266	228	DGND	2850	-266
29	C21-	-9090	-266	79	DGND	-6090	-266	129	C11-	-3090	-266	179	VCI1	-90	-266	229	VCORE	2910	-266
30	C21-	-9030	-266	80	AGND	-6030	-266	130	C11+	-3030	-266	180	VCI1	-30	-266	230	VCORE	2970	-266
31	C21-	-8970	-266	81	AGND	-5970	-266	131	C11+	-2970	-266	181	VCI1	30	-266	231	VCORE	3030	-266
32	C21-	-8910	-266	82	AGND	-5910	-266	132	C11+	-2910	-266	182	VCI1	90	-266	232	VCORE	3090	-266
33	C22+	-8850	-266	83	AGND	-5850	-266	133	C11+	-2850	-266	183	VCI1	150	-266	233	VCORE	3150	-266
34	C22+	-8790	-266	84	AGND	-5790	-266	134	C11+	-2790	-266	184	VCI1	210	-266	234	VCORE	3210	-266
35	C22+	-8730	-266	85	AGND	-5730	-266	135	C11+	-2730	-266	185	VCI1	270	-266	235	VCC	3270	-266
36	C22+	-8670	-266	86	AGND	-5670	-266	136	C11+	-2670	-266	186	VCI	330	-266	236	VCC	3330	-266
37	C22-	-8610	-266	87	AGND	-5610	-266	137	C11+	-2610	-266	187	VCI	390	-266	237	VCC	3390	-266
38	C22-	-8550	-266	88	AGND	-5550	-266	138	C11+	-2550	-266	188	VCI	450	-266	238	VCC	3450	-266
39	C22-	-8490	-266	89	VCL	-5490	-266	139	C11+	-2490	-266	189	VCI	510	-266	239	VCC	3510	-266
40	C22-	-8430	-266	90	VCL	-5430	-266	140	C11+	-2430	-266	190	VCI	570	-266	240	VCC	3570	-266
41	C23+	-8370	-266	91	VCL	-5370	-266	141	C11+	-2370	-266	191	VCI	630	-266	241	VCC	3630	-266
42	C23+	-8310	-266	92	VCL	-5310	-266	142	C12-	-2310	-266	192	VCI	690	-266	242	VCC	3690	-266
43	C23+	-8250	-266	93	VCL	-5250	-266	143	C12-	-2250	-266	193	VCI	750	-266	243	IOVCC	3750	-266
44	C23+	-8190	-266	94	VCL	-5190	-266	144	C12-	-2190	-266	194	VCI	810	-266	244	IOVCC	3810	-266
45	C23-	-8130	-266	95	VCL	-5130	-266	145	C12-	-2130	-266	195	VCI	870	-266	245	IOVCC	3870	-266
46	C23-	-8070	-266	96	C13+	-5070	-266	146	C12-	-2070	-266	196	VCI	930	-266	246	IOVCC	3930	-266
47	C23-	-8010	-266	97	C13+	-5010	-266	147	C12-	-2010	-266	197	VCI	990	-266	247	IOVCC	3990	-266
48	C23-	-7950	-266	98	C13+	-4950	-266	148	C12-	-1950	-266	198	VGS	1050	-266	248	IOVCC	4050	-266
49	VGL	-7890	-266	99	C13+	-4890	-266	149	C12-	-1890	-266	199	VSET	1110	-266	249	IOVCC	4110	-266
50	VGL	-7830	-266	100	C13+	-4830	-266	150	C12-	-1830	-266	200	VREG1OUT	1170	-266	250	IOVCC	4170	-266

No.	Name	X	Y	No.	Name	X	Y	No.	Name	X	Y	No.	Name	X	Y	No.	Name	X	Y
251	DGND	4230	-266	301	HSYNC	7230	-266	351	NC	10230	-266	401	G81	10221	246	451	G181	9321	246
252	DGND	4290	-266	302	VSYNC	7290	-266	352	NC	10290	-266	402	G83	10203	101	452	G183	9303	101
253	DGND	4350	-266	303	DE	7350	-266	353	NC	10350	-266	403	G85	10185	246	453	G185	9285	246
254	DGND	4410	-266	304	STB	7410	-266	354	NC	10410	-266	404	G87	10167	101	454	G187	9267	101
255	DGND	4470	-266	305	CF2	7470	-266	355	NC	10470	-266	405	G89	10149	246	455	G189	9249	246
256	DGND	4530	-266	306	CF1	7530	-266	356	NC	10530	-266	406	G91	10131	101	456	G191	9231	101
257	DGND	4590	-266	307	D/S	7590	-266	357	NC	10590	-266	407	G93	10113	246	457	G193	9213	246
258	DGND	4650	-266	308	TS7	7650	-266	358	NC	10650	-266	408	G95	10095	101	458	G195	9195	101
259	DGND	4710	-266	309	TS6	7710	-266	359	NC	10710	-266	409	G97	10077	246	459	G197	9177	246
260	DGND	4770	-266	310	TS5	7770	-266	360	NC	10770	-266	410	G99	10059	101	460	G199	9159	101
261	DGND	4830	-266	311	TS4	7830	-266	361	G1	10941	246	411	G101	10041	246	461	G201	9141	246
262	DGND	4890	-266	312	TS3	7890	-266	362	G3	10923	101	412	G103	10023	101	462	G203	9123	101
263	nRESET	4950	-266	313	TS2	7950	-266	363	G5	10905	246	413	G105	10005	246	463	G205	9105	246
264	EXTPSET	5010	-266	314	TS1	8010	-266	364	G7	10887	101	414	G107	9987	101	464	G207	9087	101
265	POWSEL	5070	-266	315	TS0	8070	-266	365	G9	10869	246	415	G109	9969	246	465	G209	9069	246
266	VDIR	5130	-266	316	NC	8130	-266	366	G11	10851	101	416	G111	9951	101	466	G211	9051	101
267	HDIR	5190	-266	317	NC	8190	-266	367	G13	10833	246	417	G113	9933	246	467	G213	9033	246
268	IF2	5250	-266	318	NC	8250	-266	368	G15	10815	101	418	G115	9915	101	468	G215	9015	101
269	IF1	5310	-266	319	NC	8310	-266	369	G17	10797	246	419	G117	9897	246	469	G217	8997	246
270	CSB	5370	-266	320	NC	8370	-266	370	G19	10779	101	420	G119	9879	101	470	G219	8979	101
271	SCL	5430	-266	321	NC	8430	-266	371	G21	10761	246	421	G121	9861	246	471	G221	8961	246
272	SDO	5490	-266	322	NC	8490	-266	372	G23	10743	101	422	G123	9843	101	472	G223	8943	101
273	SDA	5550	-266	323	NC	8550	-266	373	G25	10725	246	423	G125	9825	246	473	G225	8925	246
274	POL	5610	-266	324	NC	8610	-266	374	G27	10707	101	424	G127	9807	101	474	G227	8907	101
275	NTPAL	5670	-266	325	NC	8670	-266	375	G29	10689	246	425	G129	9789	246	475	G229	8889	246
276	D27	5730	-266	326	NC	8730	-266	376	G31	10671	101	426	G131	9771	101	476	G231	8871	101
277	D26	5790	-266	327	NC	8790	-266	377	G33	10653	246	427	G133	9753	246	477	G233	8853	246
278	D25	5850	-266	328	NC	8850	-266	378	G35	10635	101	428	G135	9735	101	478	G235	8835	101
279	D24	5910	-266	329	NC	8910	-266	379	G37	10617	246	429	G137	9717	246	479	G237	8817	246
280	D23	5970	-266	330	NC	8970	-266	380	G39	10599	101	430	G139	9699	101	480	G239	8799	101
281	D22	6030	-266	331	NC	9030	-266	381	G41	10581	246	431	G141	9681	246	481	Dummy	8781	246
282	D21	6090	-266	332	NC	9090	-266	382	G43	10563	101	432	G143	9663	101	482	Dummy	8763	101
283	D20	6150	-266	333	NC	9150	-266	383	G45	10545	246	433	G145	9645	246	483	S1	8731	246
284	D17	6210	-266	334	NC	9210	-266	384	G47	10527	101	434	G147	9627	101	484	S2	8713	101
285	D16	6270	-266	335	NC	9270	-266	385	G49	10509	246	435	G149	9609	246	485	S3	8695	246
286	D15	6330	-266	336	NC	9330	-266	386	G51	10491	101	436	G151	9591	101	486	S4	8677	101
287	D14	6390	-266	337	NC	9390	-266	387	G53	10473	246	437	G153	9573	246	487	S5	8659	246
288	D13	6450	-266	338	NC	9450	-266	388	G55	10455	101	438	G155	9555	101	488	S6	8641	101
289	D12	6510	-266	339	NC	9510	-266	389	G57	10437	246	439	G157	9537	246	489	S7	8623	246
290	D11	6570	-266	340	NC	9570	-266	390	G59	10419	101	440	G159	9519	101	490	S8	8605	101
291	D10	6630	-266	341	NC	9630	-266	391	G61	10401	246	441	G161	9501	246	491	S9	8587	246
292	D07	6690	-266	342	NC	9690	-266	392	G63	10383	101	442	G163	9483	101	492	S10	8569	101
293	D06	6750	-266	343	NC	9750	-266	393	G65	10365	246	443	G165	9465	246	493	S11	8551	246
294	D05	6810	-266	344	NC	9810	-266	394	G67	10347	101	444	G167	9447	101	494	S12	8533	101
295	D04	6870	-266	345	NC	9870	-266	395	G69	10329	246	445	G169	9429	246	495	S13	8515	246
296	D03	6930	-266	346	NC	9930	-266	396	G71	10311	101	446	G171	9411	101	496	S14	8497	101
297	D02	6990	-266	347	NC	9990	-266	397	G73	10293	246	447	G173	9393	246	497	S15	8479	246
298	D01	7050	-266	348	NC	10050	-266	398	G75	10275	101	448	G175	9375	101	498	S16	8461	101
299	D00	7110	-266	349	NC	10110	-266	399	G77	10257	246	449	G177	9357	246	499	S17	8443	246
300	DCLK	7170	-266	350	NC	10170	-266	400	G79	10239	101	450	G179	9339	101	500	S18	8425	101

No.	Name	X	Y	No.	Name	X	Y	No.	Name	X	Y	No.	Name	X	Y	No.	Name	X	Y
501	S19	8407	246	551	S69	7507	246	601	S119	6607	246	651	S169	5707	246	701	S219	4807	246
502	S20	8389	101	552	S70	7489	101	602	S120	6589	101	652	S170	5689	101	702	S220	4789	101
503	S21	8371	246	553	S71	7471	246	603	S121	6571	246	653	S171	5671	246	703	S221	4771	246
504	S22	8353	101	554	S72	7453	101	604	S122	6553	101	654	S172	5653	101	704	S222	4753	101
505	S23	8335	246	555	S73	7435	246	605	S123	6535	246	655	S173	5635	246	705	S223	4735	246
506	S24	8317	101	556	S74	7417	101	606	S124	6517	101	656	S174	5617	101	706	S224	4717	101
507	S25	8299	246	557	S75	7399	246	607	S125	6499	246	657	S175	5599	246	707	S225	4699	246
508	S26	8281	101	558	S76	7381	101	608	S126	6481	101	658	S176	5581	101	708	S226	4681	101
509	S27	8263	246	559	S77	7363	246	609	S127	6463	246	659	S177	5563	246	709	S227	4663	246
510	S28	8245	101	560	S78	7345	101	610	S128	6445	101	660	S178	5545	101	710	S228	4645	101
511	S29	8227	246	561	S79	7327	246	611	S129	6427	246	661	S179	5527	246	711	S229	4627	246
512	S30	8209	101	562	S80	7309	101	612	S130	6409	101	662	S180	5509	101	712	S230	4609	101
513	S31	8191	246	563	S81	7291	246	613	S131	6391	246	663	S181	5491	246	713	S231	4591	246
514	S32	8173	101	564	S82	7273	101	614	S132	6373	101	664	S182	5473	101	714	S232	4573	101
515	S33	8155	246	565	S83	7255	246	615	S133	6355	246	665	S183	5455	246	715	S233	4555	246
516	S34	8137	101	566	S84	7237	101	616	S134	6337	101	666	S184	5437	101	716	S234	4537	101
517	S35	8119	246	567	S85	7219	246	617	S135	6319	246	667	S185	5419	246	717	S235	4519	246
518	S36	8101	101	568	S86	7201	101	618	S136	6301	101	668	S186	5401	101	718	S236	4501	101
519	S37	8083	246	569	S87	7183	246	619	S137	6283	246	669	S187	5383	246	719	S237	4483	246
520	S38	8065	101	570	S88	7165	101	620	S138	6265	101	670	S188	5365	101	720	S238	4465	101
521	S39	8047	246	571	S89	7147	246	621	S139	6247	246	671	S189	5347	246	721	S239	4447	246
522	S40	8029	101	572	S90	7129	101	622	S140	6229	101	672	S190	5329	101	722	S240	4429	101
523	S41	8011	246	573	S91	7111	246	623	S141	6211	246	673	S191	5311	246	723	S241	4411	246
524	S42	7993	101	574	S92	7093	101	624	S142	6193	101	674	S192	5293	101	724	S242	4393	101
525	S43	7975	246	575	S93	7075	246	625	S143	6175	246	675	S193	5275	246	725	S243	4375	246
526	S44	7957	101	576	S94	7057	101	626	S144	6157	101	676	S194	5257	101	726	S244	4357	101
527	S45	7939	246	577	S95	7039	246	627	S145	6139	246	677	S195	5239	246	727	S245	4339	246
528	S46	7921	101	578	S96	7021	101	628	S146	6121	101	678	S196	5221	101	728	S246	4321	101
529	S47	7903	246	579	S97	7003	246	629	S147	6103	246	679	S197	5203	246	729	S247	4303	246
530	S48	7885	101	580	S98	6985	101	630	S148	6085	101	680	S198	5185	101	730	S248	4285	101
531	S49	7867	246	581	S99	6967	246	631	S149	6067	246	681	S199	5167	246	731	S249	4267	246
532	S50	7849	101	582	S100	6949	101	632	S150	6049	101	682	S200	5149	101	732	S250	4249	101
533	S51	7831	246	583	S101	6931	246	633	S151	6031	246	683	S201	5131	246	733	S251	4231	246
534	S52	7813	101	584	S102	6913	101	634	S152	6013	101	684	S202	5113	101	734	S252	4213	101
535	S53	7795	246	585	S103	6895	246	635	S153	5995	246	685	S203	5095	246	735	S253	4195	246
536	S54	7777	101	586	S104	6877	101	636	S154	5977	101	686	S204	5077	101	736	S254	4177	101
537	S55	7759	246	587	S105	6859	246	637	S155	5959	246	687	S205	5059	246	737	S255	4159	246
538	S56	7741	101	588	S106	6841	101	638	S156	5941	101	688	S206	5041	101	738	S256	4141	101
539	S57	7723	246	589	S107	6823	246	639	S157	5923	246	689	S207	5023	246	739	S257	4123	246
540	S58	7705	101	590	S108	6805	101	640	S158	5905	101	690	S208	5005	101	740	S258	4105	101
541	S59	7687	246	591	S109	6787	246	641	S159	5887	246	691	S209	4987	246	741	S259	4087	246
542	S60	7669	101	592	S110	6769	101	642	S160	5869	101	692	S210	4969	101	742	S260	4069	101
543	S61	7651	246	593	S111	6751	246	643	S161	5851	246	693	S211	4951	246	743	S261	4051	246
544	S62	7633	101	594	S112	6733	101	644	S162	5833	101	694	S212	4933	101	744	S262	4033	101
545	S63	7615	246	595	S113	6715	246	645	S163	5815	246	695	S213	4915	246	745	S263	4015	246
546	S64	7597	101	596	S114	6697	101	646	S164	5797	101	696	S214	4897	101	746	S264	3997	101
547	S65	7579	246	597	S115	6679	246	647	S165	5779	246	697	S215	4879	246	747	S265	3979	246
548	S66	7561	101	598	S116	6661	101	648	S166	5761	101	698	S216	4861	101	748	S266	3961	101
549	S67	7543	246	599	S117	6643	246	649	S167	5743	246	699	S217	4843	246	749	S267	3943	246
550	S68	7525	101	600	S118	6625	101	650	S168	5725	101	700	S218	4825	101	750	S268	3925	101

No.	Name	X	Y	No.	Name	X	Y	No.	Name	X	Y	No.	Name	X	Y	No.	Name	X	Y
751	S269	3907	246	801	S319	3007	246	851	S369	2107	246	901	S419	1207	246	951	S469	307	246
752	S270	3889	101	802	S320	2989	101	852	S370	2089	101	902	S420	1189	101	952	S470	289	101
753	S271	3871	246	803	S321	2971	246	853	S371	2071	246	903	S421	1171	246	953	S471	271	246
754	S272	3853	101	804	S322	2953	101	854	S372	2053	101	904	S422	1153	101	954	S472	253	101
755	S273	3835	246	805	S323	2935	246	855	S373	2035	246	905	S423	1135	246	955	S473	235	246
756	S274	3817	101	806	S324	2917	101	856	S374	2017	101	906	S424	1117	101	956	S474	217	101
757	S275	3799	246	807	S325	2899	246	857	S375	1999	246	907	S425	1099	246	957	S475	199	246
758	S276	3781	101	808	S326	2881	101	858	S376	1981	101	908	S426	1081	101	958	S476	181	101
759	S277	3763	246	809	S327	2863	246	859	S377	1963	246	909	S427	1063	246	959	S477	163	246
760	S278	3745	101	810	S328	2845	101	860	S378	1945	101	910	S428	1045	101	960	S478	145	101
761	S279	3727	246	811	S329	2827	246	861	S379	1927	246	911	S429	1027	246	961	S479	127	246
762	S280	3709	101	812	S330	2809	101	862	S380	1909	101	912	S430	1009	101	962	S480	109	101
763	S281	3691	246	813	S331	2791	246	863	S381	1891	246	913	S431	991	246	963	DUMMY	91	246
764	S282	3673	101	814	S332	2773	101	864	S382	1873	101	914	S432	973	101	964	DUMMY	73	101
765	S283	3655	246	815	S333	2755	246	865	S383	1855	246	915	S433	955	246	965	DUMMY	55	246
766	S284	3637	101	816	S334	2737	101	866	S384	1837	101	916	S434	937	101	966	DUMMY	37	101
767	S285	3619	246	817	S335	2719	246	867	S385	1819	246	917	S435	919	246	967	DUMMY	19	246
768	S286	3601	101	818	S336	2701	101	868	S386	1801	101	918	S436	901	101	968	DUMMY	-19	101
769	S287	3583	246	819	S337	2683	246	869	S387	1783	246	919	S437	883	246	969	DUMMY	-37	246
770	S288	3565	101	820	S338	2665	101	870	S388	1765	101	920	S438	865	101	970	DUMMY	-55	101
771	S289	3547	246	821	S339	2647	246	871	S389	1747	246	921	S439	847	246	971	DUMMY	-73	246
772	S290	3529	101	822	S340	2629	101	872	S390	1729	101	922	S440	829	101	972	DUMMY	-91	101
773	S291	3511	246	823	S341	2611	246	873	S391	1711	246	923	S441	811	246	973	S481	-109	246
774	S292	3493	101	824	S342	2593	101	874	S392	1693	101	924	S442	793	101	974	S482	-127	101
775	S293	3475	246	825	S343	2575	246	875	S393	1675	246	925	S443	775	246	975	S483	-145	246
776	S294	3457	101	826	S344	2557	101	876	S394	1657	101	926	S444	757	101	976	S484	-163	101
777	S295	3439	246	827	S345	2539	246	877	S395	1639	246	927	S445	739	246	977	S485	-181	246
778	S296	3421	101	828	S346	2521	101	878	S396	1621	101	928	S446	721	101	978	S486	-199	101
779	S297	3403	246	829	S347	2503	246	879	S397	1603	246	929	S447	703	246	979	S487	-217	246
780	S298	3385	101	830	S348	2485	101	880	S398	1585	101	930	S448	685	101	980	S488	-235	101
781	S299	3367	246	831	S349	2467	246	881	S399	1567	246	931	S449	667	246	981	S489	-253	246
782	S300	3349	101	832	S350	2449	101	882	S400	1549	101	932	S450	649	101	982	S490	-271	101
783	S301	3331	246	833	S351	2431	246	883	S401	1531	246	933	S451	631	246	983	S491	-289	246
784	S302	3313	101	834	S352	2413	101	884	S402	1513	101	934	S452	613	101	984	S492	-307	101
785	S303	3295	246	835	S353	2395	246	885	S403	1495	246	935	S453	595	246	985	S493	-325	246
786	S304	3277	101	836	S354	2377	101	886	S404	1477	101	936	S454	577	101	986	S494	-343	101
787	S305	3259	246	837	S355	2359	246	887	S405	1459	246	937	S455	559	246	987	S495	-361	246
788	S306	3241	101	838	S356	2341	101	888	S406	1441	101	938	S456	541	101	988	S496	-379	101
789	S307	3223	246	839	S357	2323	246	889	S407	1423	246	939	S457	523	246	989	S497	-397	246
790	S308	3205	101	840	S358	2305	101	890	S408	1405	101	940	S458	505	101	990	S498	-415	101
791	S309	3187	246	841	S359	2287	246	891	S409	1387	246	941	S459	487	246	991	S499	-433	246
792	S310	3169	101	842	S360	2269	101	892	S410	1369	101	942	S460	469	101	992	S500	-451	101
793	S311	3151	246	843	S361	2251	246	893	S411	1351	246	943	S461	451	246	993	S501	-469	246
794	S312	3133	101	844	S362	2233	101	894	S412	1333	101	944	S462	433	101	994	S502	-487	101
795	S313	3115	246	845	S363	2215	246	895	S413	1315	246	945	S463	415	246	995	S503	-505	246
796	S314	3097	101	846	S364	2197	101	896	S414	1297	101	946	S464	397	101	996	S504	-523	101
797	S315	3079	246	847	S365	2179	246	897	S415	1279	246	947	S465	379	246	997	S505	-541	246
798	S316	3061	101	848	S366	2161	101	898	S416	1261	101	948	S466	361	101	998	S506	-559	101
799	S317	3043	246	849	S367	2143	246	899	S417	1243	246	949	S467	343	246	999	S507	-577	246
800	S318	3025	101	850	S368	2125	101	900	S418	1225	101	950	S468	325	101	1000	S508	-595	101

No.	Name	X	Y	No.	Name	X	Y	No.	Name	X	Y	No.	Name	X	Y	No.	Name	X	Y
1001	S509	-613	246	1051	S559	-1513	246	1101	S609	-2413	246	1151	S659	-3313	246	1201	S709	-4213	246
1002	S510	-631	101	1052	S560	-1531	101	1102	S610	-2431	101	1152	S660	-3331	101	1202	S710	-4231	101
1003	S511	-649	246	1053	S561	-1549	246	1103	S611	-2449	246	1153	S661	-3349	246	1203	S711	-4249	246
1004	S512	-667	101	1054	S562	-1567	101	1104	S612	-2467	101	1154	S662	-3367	101	1204	S712	-4267	101
1005	S513	-685	246	1055	S563	-1585	246	1105	S613	-2485	246	1155	S663	-3385	246	1205	S713	-4285	246
1006	S514	-703	101	1056	S564	-1603	101	1106	S614	-2503	101	1156	S664	-3403	101	1206	S714	-4303	101
1007	S515	-721	246	1057	S565	-1621	246	1107	S615	-2521	246	1157	S665	-3421	246	1207	S715	-4321	246
1008	S516	-739	101	1058	S566	-1639	101	1108	S616	-2539	101	1158	S666	-3439	101	1208	S716	-4339	101
1009	S517	-757	246	1059	S567	-1657	246	1109	S617	-2557	246	1159	S667	-3457	246	1209	S717	-4357	246
1010	S518	-775	101	1060	S568	-1675	101	1110	S618	-2575	101	1160	S668	-3475	101	1210	S718	-4375	101
1011	S519	-793	246	1061	S569	-1693	246	1111	S619	-2593	246	1161	S669	-3493	246	1211	S719	-4393	246
1012	S520	-811	101	1062	S570	-1711	101	1112	S620	-2611	101	1162	S670	-3511	101	1212	S720	-4411	101
1013	S521	-829	246	1063	S571	-1729	246	1113	S621	-2629	246	1163	S671	-3529	246	1213	S721	-4429	246
1014	S522	-847	101	1064	S572	-1747	101	1114	S622	-2647	101	1164	S672	-3547	101	1214	S722	-4447	101
1015	S523	-865	246	1065	S573	-1765	246	1115	S623	-2665	246	1165	S673	-3565	246	1215	S723	-4465	246
1016	S524	-883	101	1066	S574	-1783	101	1116	S624	-2683	101	1166	S674	-3583	101	1216	S724	-4483	101
1017	S525	-901	246	1067	S575	-1801	246	1117	S625	-2701	246	1167	S675	-3601	246	1217	S725	-4501	246
1018	S526	-919	101	1068	S576	-1819	101	1118	S626	-2719	101	1168	S676	-3619	101	1218	S726	-4519	101
1019	S527	-937	246	1069	S577	-1837	246	1119	S627	-2737	246	1169	S677	-3637	246	1219	S727	-4537	246
1020	S528	-955	101	1070	S578	-1855	101	1120	S628	-2755	101	1170	S678	-3655	101	1220	S728	-4555	101
1021	S529	-973	246	1071	S579	-1873	246	1121	S629	-2773	246	1171	S679	-3673	246	1221	S729	-4573	246
1022	S530	-991	101	1072	S580	-1891	101	1122	S630	-2791	101	1172	S680	-3691	101	1222	S730	-4591	101
1023	S531	-1009	246	1073	S581	-1909	246	1123	S631	-2809	246	1173	S681	-3709	246	1223	S731	-4609	246
1024	S532	-1027	101	1074	S582	-1927	101	1124	S632	-2827	101	1174	S682	-3727	101	1224	S732	-4627	101
1025	S533	-1045	246	1075	S583	-1945	246	1125	S633	-2845	246	1175	S683	-3745	246	1225	S733	-4645	246
1026	S534	-1063	101	1076	S584	-1963	101	1126	S634	-2863	101	1176	S684	-3763	101	1226	S734	-4663	101
1027	S535	-1081	246	1077	S585	-1981	246	1127	S635	-2881	246	1177	S685	-3781	246	1227	S735	-4681	246
1028	S536	-1099	101	1078	S586	-1999	101	1128	S636	-2899	101	1178	S686	-3799	101	1228	S736	-4699	101
1029	S537	-1117	246	1079	S587	-2017	246	1129	S637	-2917	246	1179	S687	-3817	246	1229	S737	-4717	246
1030	S538	-1135	101	1080	S588	-2035	101	1130	S638	-2935	101	1180	S688	-3835	101	1230	S738	-4735	101
1031	S539	-1153	246	1081	S589	-2053	246	1131	S639	-2953	246	1181	S689	-3853	246	1231	S739	-4753	246
1032	S540	-1171	101	1082	S590	-2071	101	1132	S640	-2971	101	1182	S690	-3871	101	1232	S740	-4771	101
1033	S541	-1189	246	1083	S591	-2089	246	1133	S641	-2989	246	1183	S691	-3889	246	1233	S741	-4789	246
1034	S542	-1207	101	1084	S592	-2107	101	1134	S642	-3007	101	1184	S692	-3907	101	1234	S742	-4807	101
1035	S543	-1225	246	1085	S593	-2125	246	1135	S643	-3025	246	1185	S693	-3925	246	1235	S743	-4825	246
1036	S544	-1243	101	1086	S594	-2143	101	1136	S644	-3043	101	1186	S694	-3943	101	1236	S744	-4843	101
1037	S545	-1261	246	1087	S595	-2161	246	1137	S645	-3061	246	1187	S695	-3961	246	1237	S745	-4861	246
1038	S546	-1279	101	1088	S596	-2179	101	1138	S646	-3079	101	1188	S696	-3979	101	1238	S746	-4879	101
1039	S547	-1297	246	1089	S597	-2197	246	1139	S647	-3097	246	1189	S697	-3997	246	1239	S747	-4897	246
1040	S548	-1315	101	1090	S598	-2215	101	1140	S648	-3115	101	1190	S698	-4015	101	1240	S748	-4915	101
1041	S549	-1333	246	1091	S599	-2233	246	1141	S649	-3133	246	1191	S699	-4033	246	1241	S749	-4933	246
1042	S550	-1351	101	1092	S600	-2251	101	1142	S650	-3151	101	1192	S700	-4051	101	1242	S750	-4951	101
1043	S551	-1369	246	1093	S601	-2269	246	1143	S651	-3169	246	1193	S701	-4069	246	1243	S751	-4969	246
1044	S552	-1387	101	1094	S602	-2287	101	1144	S652	-3187	101	1194	S702	-4087	101	1244	S752	-4987	101
1045	S553	-1405	246	1095	S603	-2305	246	1145	S653	-3205	246	1195	S703	-4105	246	1245	S753	-5005	246
1046	S554	-1423	101	1096	S604	-2323	101	1146	S654	-3223	101	1196	S704	-4123	101	1246	S754	-5023	101
1047	S555	-1441	246	1097	S605	-2341	246	1147	S655	-3241	246	1197	S705	-4141	246	1247	S755	-5041	246
1048	S556	-1459	101	1098	S606	-2359	101	1148	S656	-3259	101	1198	S706	-4159	101	1248	S756	-5059	101
1049	S557	-1477	246	1099	S607	-2377	246	1149	S657	-3277	246	1199	S707	-4177	246	1249	S757	-5077	246
1050	S558	-1495	101	1100	S608	-2395	101	1150	S658	-3295	101	1200	S708	-4195	101	1250	S758	-5095	101

No.	Name	X	Y	No.	Name	X	Y	No.	Name	X	Y	No.	Name	X	Y	No.	Name	X	Y
1251	S759	-5113	246	1301	S809	-6013	246	1351	S859	-6913	246	1401	S909	-7813	246	1451	S959	-8713	246
1252	S760	-5131	101	1302	S810	-6031	101	1352	S860	-6931	101	1402	S910	-7831	101	1452	S960	-8731	101
1253	S761	-5149	246	1303	S811	-6049	246	1353	S861	-6949	246	1403	S911	-7849	246	1453	Dummy	-8763	246
1254	S762	-5167	101	1304	S812	-6067	101	1354	S862	-6967	101	1404	S912	-7867	101	1454	Dummy	-8781	101
1255	S763	-5185	246	1305	S813	-6085	246	1355	S863	-6985	246	1405	S913	-7885	246	1455	G240	-8799	246
1256	S764	-5203	101	1306	S814	-6103	101	1356	S864	-7003	101	1406	S914	-7903	101	1456	G238	-8817	101
1257	S765	-5221	246	1307	S815	-6121	246	1357	S865	-7021	246	1407	S915	-7921	246	1457	G236	-8835	246
1258	S766	-5239	101	1308	S816	-6139	101	1358	S866	-7039	101	1408	S916	-7939	101	1458	G234	-8853	101
1259	S767	-5257	246	1309	S817	-6157	246	1359	S867	-7057	246	1409	S917	-7957	246	1459	G232	-8871	246
1260	S768	-5275	101	1310	S818	-6175	101	1360	S868	-7075	101	1410	S918	-7975	101	1460	G230	-8889	101
1261	S769	-5293	246	1311	S819	-6193	246	1361	S869	-7093	246	1411	S919	-7993	246	1461	G228	-8907	246
1262	S770	-5311	101	1312	S820	-6211	101	1362	S870	-7111	101	1412	S920	-8011	101	1462	G226	-8925	101
1263	S771	-5329	246	1313	S821	-6229	246	1363	S871	-7129	246	1413	S921	-8029	246	1463	G224	-8943	246
1264	S772	-5347	101	1314	S822	-6247	101	1364	S872	-7147	101	1414	S922	-8047	101	1464	G222	-8961	101
1265	S773	-5365	246	1315	S823	-6265	246	1365	S873	-7165	246	1415	S923	-8065	246	1465	G220	-8979	246
1266	S774	-5383	101	1316	S824	-6283	101	1366	S874	-7183	101	1416	S924	-8083	101	1466	G218	-8997	101
1267	S775	-5401	246	1317	S825	-6301	246	1367	S875	-7201	246	1417	S925	-8101	246	1467	G216	-9015	246
1268	S776	-5419	101	1318	S826	-6319	101	1368	S876	-7219	101	1418	S926	-8119	101	1468	G214	-9033	101
1269	S777	-5437	246	1319	S827	-6337	246	1369	S877	-7237	246	1419	S927	-8137	246	1469	G212	-9051	246
1270	S778	-5455	101	1320	S828	-6355	101	1370	S878	-7255	101	1420	S928	-8155	101	1470	G210	-9069	101
1271	S779	-5473	246	1321	S829	-6373	246	1371	S879	-7273	246	1421	S929	-8173	246	1471	G208	-9087	246
1272	S780	-5491	101	1322	S830	-6391	101	1372	S880	-7291	101	1422	S930	-8191	101	1472	G206	-9105	101
1273	S781	-5509	246	1323	S831	-6409	246	1373	S881	-7309	246	1423	S931	-8209	246	1473	G204	-9123	246
1274	S782	-5527	101	1324	S832	-6427	101	1374	S882	-7327	101	1424	S932	-8227	101	1474	G202	-9141	101
1275	S783	-5545	246	1325	S833	-6445	246	1375	S883	-7345	246	1425	S933	-8245	246	1475	G200	-9159	246
1276	S784	-5563	101	1326	S834	-6463	101	1376	S884	-7363	101	1426	S934	-8263	101	1476	G198	-9177	101
1277	S785	-5581	246	1327	S835	-6481	246	1377	S885	-7381	246	1427	S935	-8281	246	1477	G196	-9195	246
1278	S786	-5599	101	1328	S836	-6499	101	1378	S886	-7399	101	1428	S936	-8299	101	1478	G194	-9213	101
1279	S787	-5617	246	1329	S837	-6517	246	1379	S887	-7417	246	1429	S937	-8317	246	1479	G192	-9231	246
1280	S788	-5635	101	1330	S838	-6535	101	1380	S888	-7435	101	1430	S938	-8335	101	1480	G190	-9249	101
1281	S789	-5653	246	1331	S839	-6553	246	1381	S889	-7453	246	1431	S939	-8353	246	1481	G188	-9267	246
1282	S790	-5671	101	1332	S840	-6571	101	1382	S890	-7471	101	1432	S940	-8371	101	1482	G186	-9285	101
1283	S791	-5689	246	1333	S841	-6589	246	1383	S891	-7489	246	1433	S941	-8389	246	1483	G184	-9303	246
1284	S792	-5707	101	1334	S842	-6607	101	1384	S892	-7507	101	1434	S942	-8407	101	1484	G182	-9321	101
1285	S793	-5725	246	1335	S843	-6625	246	1385	S893	-7525	246	1435	S943	-8425	246	1485	G180	-9339	246
1286	S794	-5743	101	1336	S844	-6643	101	1386	S894	-7543	101	1436	S944	-8443	101	1486	G178	-9357	101
1287	S795	-5761	246	1337	S845	-6661	246	1387	S895	-7561	246	1437	S945	-8461	246	1487	G176	-9375	246
1288	S796	-5779	101	1338	S846	-6679	101	1388	S896	-7579	101	1438	S946	-8479	101	1488	G174	-9393	101
1289	S797	-5797	246	1339	S847	-6697	246	1389	S897	-7597	246	1439	S947	-8497	246	1489	G172	-9411	246
1290	S798	-5815	101	1340	S848	-6715	101	1390	S898	-7615	101	1440	S948	-8515	101	1490	G170	-9429	101
1291	S799	-5833	246	1341	S849	-6733	246	1391	S899	-7633	246	1441	S949	-8533	246	1491	G168	-9447	246
1292	S800	-5851	101	1342	S850	-6751	101	1392	S900	-7651	101	1442	S950	-8551	101	1492	G166	-9465	101
1293	S801	-5869	246	1343	S851	-6769	246	1393	S901	-7669	246	1443	S951	-8569	246	1493	G164	-9483	246
1294	S802	-5887	101	1344	S852	-6787	101	1394	S902	-7687	101	1444	S952	-8587	101	1494	G162	-9501	101
1295	S803	-5905	246	1345	S853	-6805	246	1395	S903	-7705	246	1445	S953	-8605	246	1495	G160	-9519	246
1296	S804	-5923	101	1346	S854	-6823	101	1396	S904	-7723	101	1446	S954	-8623	101	1496	G158	-9537	101
1297	S805	-5941	246	1347	S855	-6841	246	1397	S905	-7741	246	1447	S955	-8641	246	1497	G156	-9555	246
1298	S806	-5959	101	1348	S856	-6859	101	1398	S906	-7759	101	1448	S956	-8659	101	1498	G154	-9573	101
1299	S807	-5977	246	1349	S857	-6877	246	1399	S907	-7777	246	1449	S957	-8677	246	1499	G152	-9591	246
1300	S808	-5995	101	1350	S858	-6895	101	1400	S908	-7795	101	1450	S958	-8695	101	1500	G150	-9609	101

No.	Name	X	Y	No.	Name	X	Y
1500	G150	-9609	101	1551	G48	-10527	246
1501	G148	-9627	246	1552	G46	-10545	101
1502	G146	-9645	101	1553	G44	-10563	246
1503	G144	-9663	246	1554	G42	-10581	101
1504	G142	-9681	101	1555	G40	-10599	246
1505	G140	-9699	246	1556	G38	-10617	101
1506	G138	-9717	101	1557	G36	-10635	246
1507	G136	-9735	246	1558	G34	-10653	101
1508	G134	-9753	101	1559	G32	-10671	246
1509	G132	-9771	246	1560	G30	-10689	101
1510	G130	-9789	101	1561	G28	-10707	246
1511	G128	-9807	246	1562	G26	-10725	101
1512	G126	-9825	101	1563	G24	-10743	246
1513	G124	-9843	246	1564	G22	-10761	101
1514	G122	-9861	101	1565	G20	-10779	246
1515	G120	-9879	246	1566	G18	-10797	101
1516	G118	-9897	101	1567	G16	-10815	246
1517	G116	-9915	246	1568	G14	-10833	101
1518	G114	-9933	101	1569	G12	-10851	246
1519	G112	-9951	246	1570	G10	-10869	101
1520	G110	-9969	101	1571	G8	-10887	246
1521	G108	-9987	246	1572	G6	-10905	101
1522	G106	-10005	101	1573	G4	-10923	246
1523	G104	-10023	246	1574	G2	-10941	101
1524	G102	-10041	101	Alignment Mark			
1525	G100	-10059	246		(-10945, -255)		
1526	G98	-10077	101		(10945, -255)		
1527	G96	-10095	246				
1528	G94	-10113	101				
1529	G92	-10131	246				
1530	G90	-10149	101				
1531	G88	-10167	246				
1532	G86	-10185	101				
1533	G84	-10203	246				
1534	G82	-10221	101				
1535	G80	-10239	246				
1536	G78	-10257	101				
1537	G76	-10275	246				
1538	G74	-10293	101				
1539	G72	-10311	246				
1540	G70	-10329	101				
1541	G68	-10347	246				
1542	G66	-10365	101				
1543	G64	-10383	246				
1544	G62	-10401	101				
1545	G60	-10419	246				
1546	G58	-10437	101				
1547	G56	-10455	246				
1548	G54	-10473	101				
1549	G52	-10491	246				

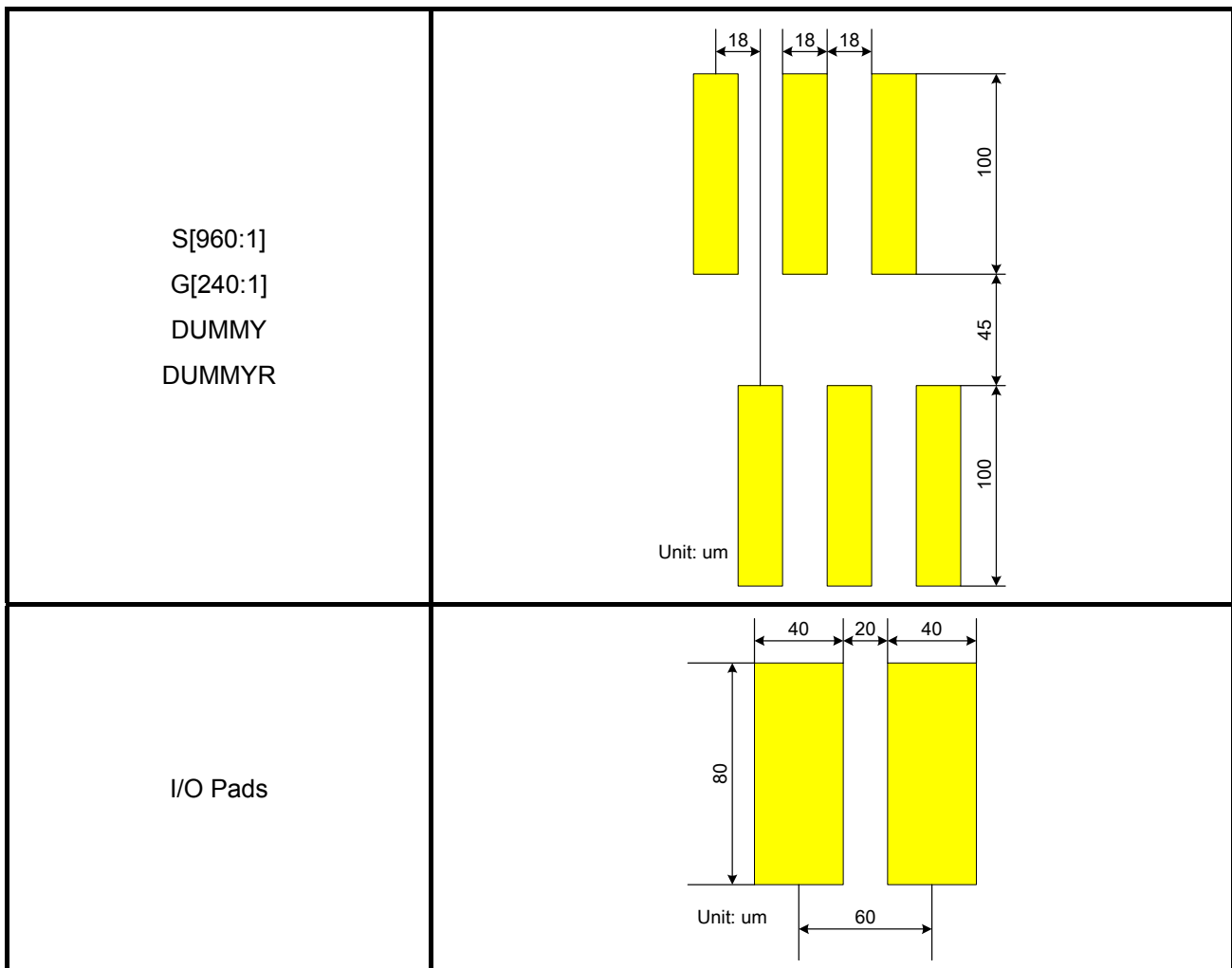

6. System Interface

6.1. Input Interfaces

6.1.1. ITU-R BT.601 Interface

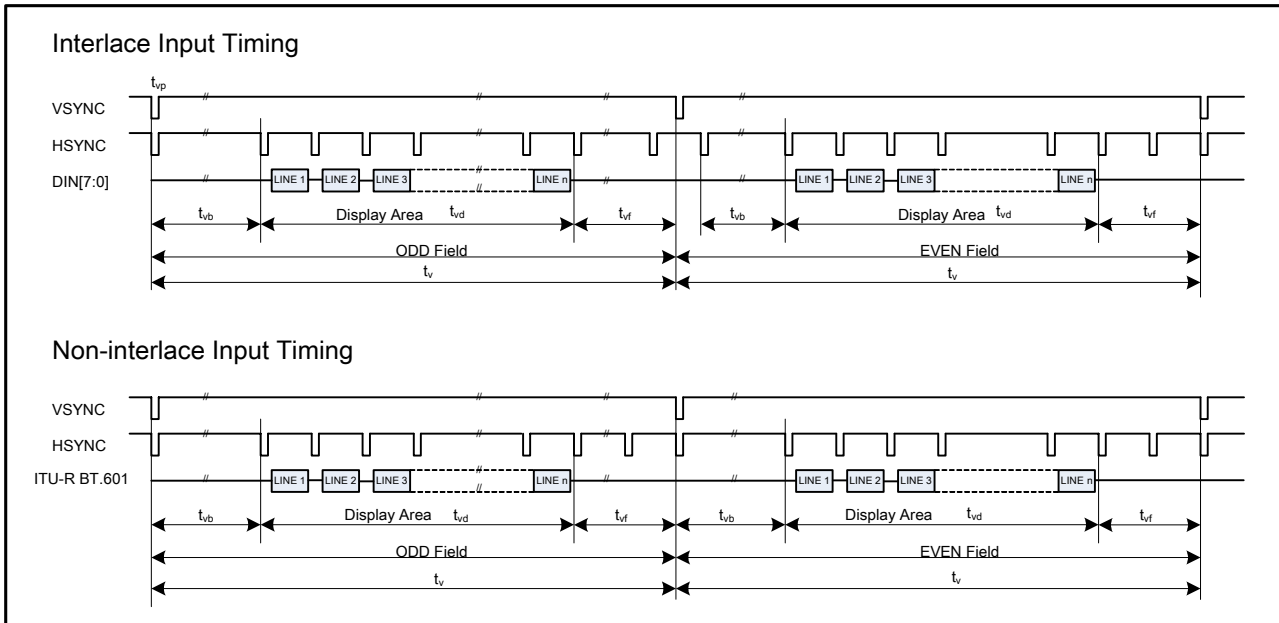

Figure1 ITR-R BT.601 Vertical Input Signal

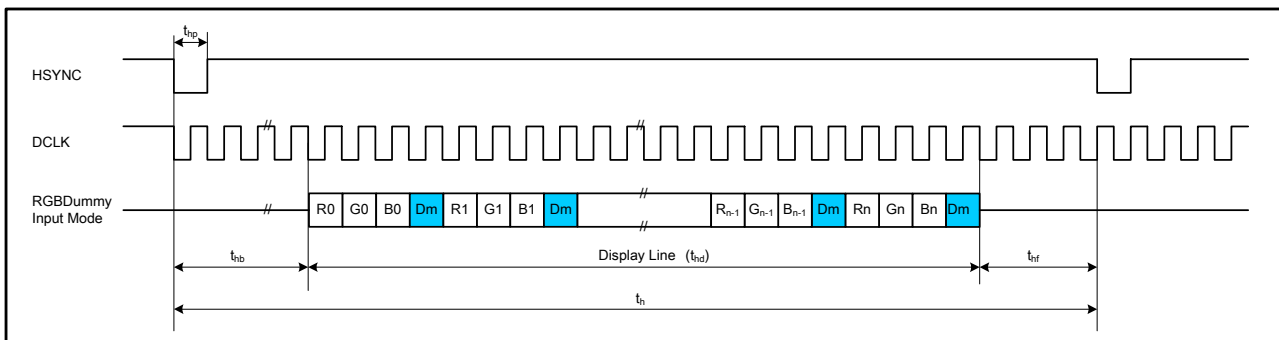

Figure2 ITR-R BT.601 Horizontal Input Signal

ITU-R BT.601 27 MHz (360 Mode) timing specifications:

Parameter	Symbol	Min.	Typ.	Max.	Unit.	Note
DCLK Frequency	$1/t_{DCLK}$	-	27	-	MHZ	
Horizontal Period	t_h	-	1716	-	t_{DCLK}	
Horizontal Display Period	t_{hd}	1440	1440	1440	t_{DCLK}	
Horizontal Back Porch	t_{hb}	2	252	-	t_{DCLK}	
Horizontal Front Porch	t_{hf}	2	24	-	t_{DCLK}	
Horizontal Pulse Width	t_{hp}	1	1	-	t_{DCLK}	
Vertical Period	t_v	-	262.5 (312.5)	-	t_h	
Vertical Display Period	t_{vd}	-	240 (288)	-	t_h	
Vertical Back Porch	t_{vb}	2	18	-	t_h	
Vertical Front Porch	t_{vf}	2	4	-	t_h	
Vertical Pulse Width	t_{vp}	1	1	-	t_h	
Data setup time	t_{su}	12	-	-	ns	
Data hold time	t_{hold}	12	-	-	ns	

ITU-R BT.601 24.54 MHz (320 Mode) timing specifications:

Parameter	Symbol	Min.	Typ.	Max.	Unit.	Note
DCLK Frequency	$1/t_{DCLK}$	-	24.54	-	MHZ	
Horizontal Period	t_h	-	1560	-	t_{DCLK}	
Horizontal Display Period	t_{hd}	1280	1280	1280	t_{DCLK}	
Horizontal Back Porch	t_{hb}	2	252	-	t_{DCLK}	
Horizontal Front Porch	t_{hf}	2	28	-	t_{DCLK}	
Horizontal Pulse Width	t_{hp}	1	1	-	t_{DCLK}	
Vertical Period	t_v	-	262.5 (312.5)	-	t_h	
Vertical Display Period	t_{vd}	-	240 (288)	-	t_h	
Vertical Back Porch	t_{vb}	2	18	-	t_h	
Vertical Front Porch	t_{vf}	2	4	-	t_h	
Vertical Pulse Width	t_{vp}	1	1	-	t_h	
Data setup time	t_{su}	12	-	-	ns	
Data hold time	t_{hold}	12	-	-	ns	

Note

1. Horizontal back porch time (H_BP) is adjustable by setting register HBP; requirement of min. back porch and min. front porch time must be satisfied.
2. Vertical back porch time (V_BP) is adjustable by setting register VBP; requirement of min. back porch and min. front porch time must be satisfied.
3. Interlace and non-interlace vertical input interfaces are acceptable.

6.1.2. ITU-R BT.656 Interface

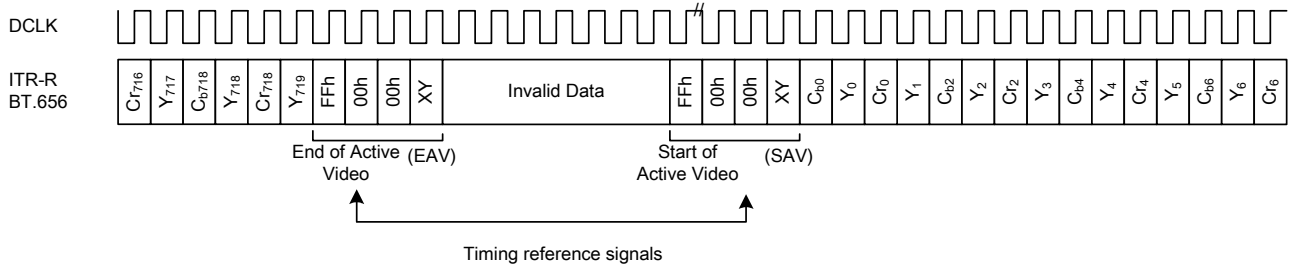

Figure3 ITR-R BT.656 Input Signal

Note:

1. FFh, 00h, 00h, XY signals are involved with the HSYNC, VSYNC and Field signals

F: field indication

V: Vertical blanking indication

H: Horizontal blanking indication

P3 ~ P0: protection bits

$$P3 = V \oplus H, \quad P2 = F \oplus H, \quad P1 = F \oplus V, \quad P0 = F \oplus V \oplus H$$

Data bit number	First Word (FFh)	Second Word (00h)	Third Word (00h)	Fourth Word (XY)
7 (MSB)	1	0	0	1
6	1	0	0	F
5	1	0	0	V
4	1	0	0	H
3	1	0	0	P3
2	1	0	0	P2
1	1	0	0	P1
0 (LSB)	1	0	0	P0

2. Horizontal blanking section consists of repeating pattern 80, 10, 80, 10.

BT.656 27 MHz (360 Mode) timing specifications:

Parameter	Symbol	Min.	Typ.	Max.	Unit.	Note
DCLK Frequency	1/t _{DCLK}	-	27	-	MHZ	
Horizontal Period	t _h	-	1716	-	t _{DCLK}	
Horizontal Display Period	t _{hd}	1440	1440	1440	t _{DCLK}	
Horizontal Back Porch	t _{hb}	2	273	-	t _{DCLK}	
Horizontal Front Porch	t _{hf}	2	3	-	t _{DCLK}	
Horizontal Pulse Width	t _{hp}	1	1	-	t _{DCLK}	
Vertical Period	t _v	-	262.5 (312.5)	-	t _h	
Vertical Display Period	t _{vd}	-	240 (288)	-	t _h	
Vertical Back Porch	t _{vb}	2	18	-	t _h	
Vertical Front Porch	t _{vf}	2	4	-	t _h	
Vertical Pulse Width	t _{vp}	1	1	-	t _h	
Data setup time	t _{su}	12	-	-	ns	
Data hold time	t _{hold}	12	-	-	ns	

The information contained herein is the exclusive property of ILI Technology Corp. and shall not be distributed, reproduced, or disclosed in whole or in part without prior written permission of ILI Technology Corp.

ITU-R BT.656 24.54 MHz (320 Mode) timing specifications:

Parameter	Symbol	Min.	Typ.	Max.	Unit.	Note
DCLK Frequency	$1/t_{DCLK}$	-	24.54	-	MHZ	
Horizontal Period	t_h	-	1560	-	t_{DCLK}	
Horizontal Display Period	t_{hd}	1280	1280	1280	t_{DCLK}	
Horizontal Back Porch	t_{hb}	2	273	-	t_{DCLK}	
Horizontal Front Porch	t_{hf}	2	7	-	t_{DCLK}	
Horizontal Pulse Width	t_{hp}	1	1	-	t_{DCLK}	
Vertical Period	t_v	-	262.5 (312.5)	-	t_h	
Vertical Display Period	t_{vd}	-	240 (288)	-	t_h	
Vertical Back Porch	t_{vb}	2	18	-	t_h	
Vertical Front Porch	t_{vf}	2	4	-	t_h	
Vertical Pulse Width	t_{vp}	1	1	-	t_h	
Data setup time	t_{su}	12	-	-	ns	
Data hold time	t_{hold}	12	-	-	ns	

Note

1. Horizontal back porch time (H_BP) is adjustable by setting register HBP; requirement of min. back porch and min. front porch time must be satisfied.
2. Vertical back porch time (V_BP) is adjustable by setting register VBP; requirement of min. back porch and min. front porch time must be satisfied.
3. Interlace and non-interlace vertical input interfaces are acceptable.

6.1.3. 8-bit Serial RGB Interface

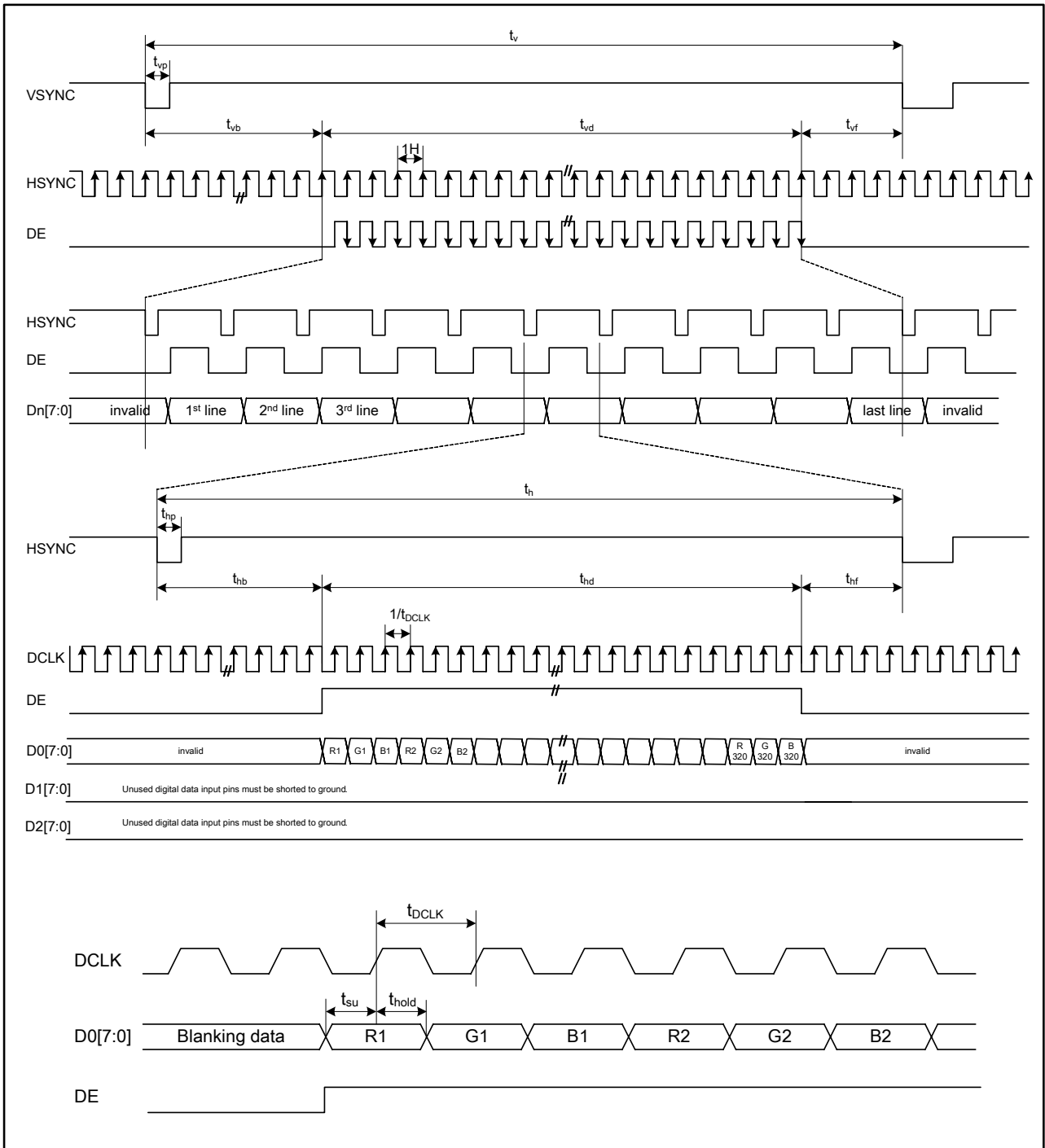

Figure4 Serial RGB Input Signal Timing

24.535MHz Mode timing specifications:

Parameter	Symbol	Min.	Typ.	Max.	Unit.	Note
DCLK Frequency	$1/t_{DCLK}$	-	24.535	-	MHZ	
Horizontal Period	t_h	-	1560	-	t_{DCLK}	
Horizontal Display Period	t_{hd}	960	960	960	t_{DCLK}	
Horizontal Back Porch	t_{hb}	2	241	-	t_{DCLK}	
Horizontal Front Porch	t_{hf}	2	359	-	t_{DCLK}	
Horizontal Pulse Width	t_{hp}	1	1	-	t_{DCLK}	
Vertical Period	t_v	-	262	-	t_h	
Vertical Display Period	t_{vd}	240	240	240	t_h	
Vertical Back Porch	t_{vb}	2	18	-	t_h	
Vertical Front Porch	t_{vf}	1	4	-	t_h	
Vertical Pulse Width	t_{vp}	1	1	-	t_h	
Data setup time	t_{su}	12	-	-	ns	
Data hold time	t_{hold}	12	-	-	ns	

20MHz Mode timing specifications:

Parameter	Symbol	Min.	Typ.	Max.	Unit.	Note
DCLK Frequency	$1/t_{DCLK}$	-	20	-	MHZ	
Horizontal Period	t_h	-	1360	-	t_{DCLK}	
Horizontal Display Period	t_{hd}	960	960	960	t_{DCLK}	
Horizontal Back Porch	t_{hb}	2	241	-	t_{DCLK}	
Horizontal Front Porch	t_{hf}	2	159	-	t_{DCLK}	
Horizontal Pulse Width	t_{hp}	1	1	-	t_{DCLK}	
Vertical Period	t_v	-	245	-	t_h	
Vertical Display Period	t_{vd}	240	240	240	t_h	
Vertical Back Porch	t_{vb}	2	4	-	t_h	
Vertical Front Porch	t_{vf}	1	1	-	t_h	
Vertical Pulse Width	t_{vp}	1	1	-	t_h	
Data setup time	t_{su}	12	-	-	ns	
Data hold time	t_{hold}	12	-	-	ns	

Note

- ◆ Horizontal back porch time (t_{hb}) is adjustable by setting register HBP; requirement of min. back porch and min. front porch time must be satisfied.
- ◆ Vertical back porch time (t_{vb}) is adjustable by setting register VBP; requirement of min. back porch and min. front porch time must be satisfied.
- ◆ Interlace and non-interlace vertical input interfaces are acceptable.

6.1.4. 8-bit Serial RGB Dummy Interface

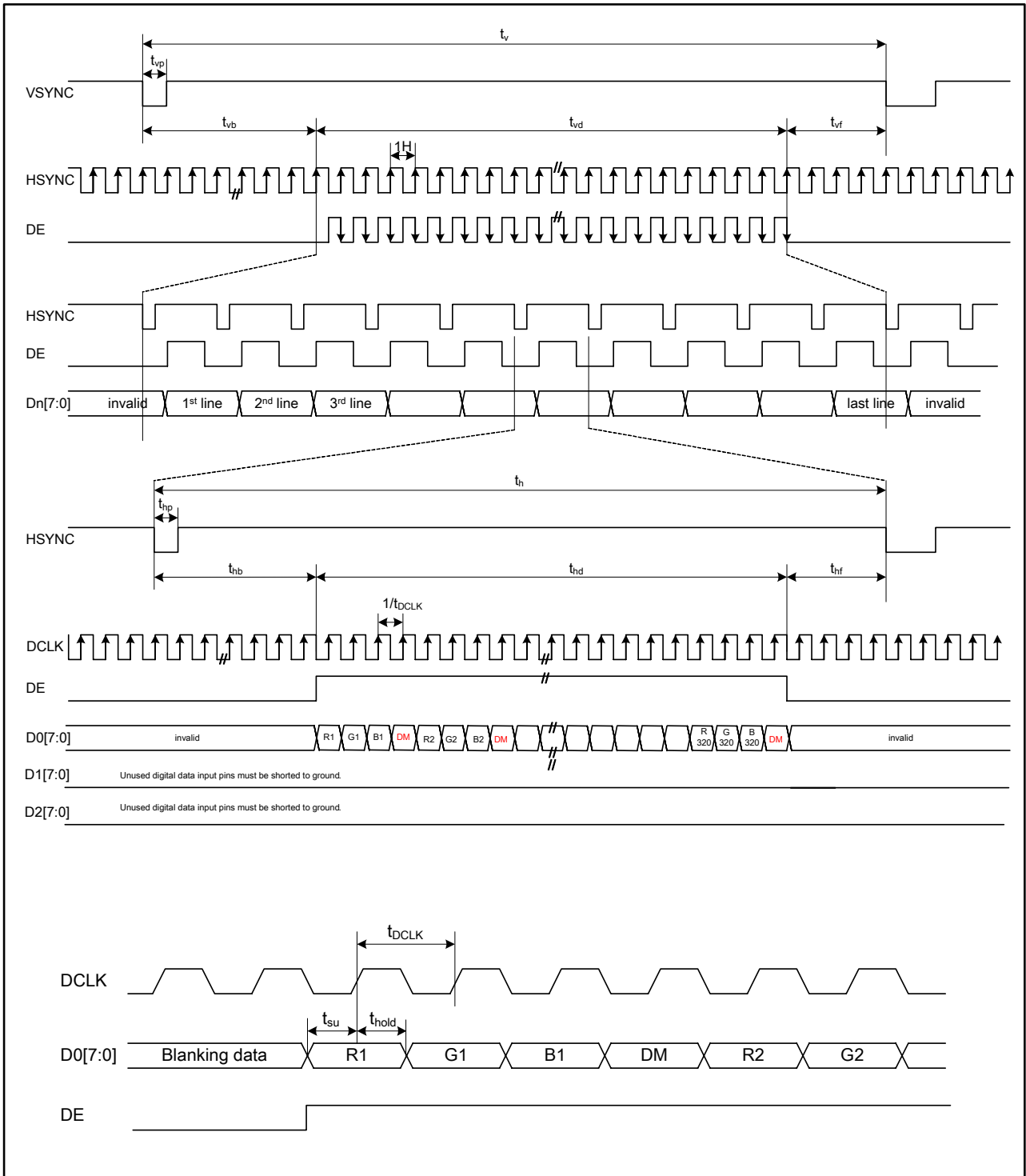

Figure5 8-bit Serial RGB Dummy Input Signal Timing

360 (NTSC) Mode timing specifications:

Parameter	Symbol	Min.	Typ.	Max.	Unit.	Note
DCLK Frequency	$1/t_{DCLK}$	-	27	-	MHZ	
Horizontal Period	t_h	-	1716	-	t_{DCLK}	
Horizontal Display Period	t_{hd}	1440	1440	1440	t_{DCLK}	
Horizontal Back Porch	t_{hb}	2	241	-	t_{DCLK}	
Horizontal Front Porch	t_{hf}	2	35	-	t_{DCLK}	
Horizontal Pulse Width	t_{hp}	1	1	-	t_{DCLK}	
Vertical Period	t_v	-	262	-	t_h	
Vertical Display Period	t_{vd}	240	240	240	t_h	
Vertical Back Porch	t_{vb}	2	21	-	t_h	
Vertical Pulse Width	t_{vp}	1	1	-	t_h	
Data setup time	t_{su}	12	-	-	ns	
Data hold time	t_{hold}	12	-	-	ns	

360 (PAL) Mode timing specifications:

Parameter	Symbol	Min.	Typ.	Max.	Unit.	Note
DCLK Frequency	$1/t_{DCLK}$	-	27	-	MHZ	
Horizontal Period	t_h	-	1728	-	t_{DCLK}	
Horizontal Display Period	t_{hd}	1440	1440	1440	t_{DCLK}	
Horizontal Back Porch	t_{hb}	2	241	-	t_{DCLK}	
Horizontal Front Porch	t_{hf}	2	46	-	t_{DCLK}	
Horizontal Pulse Width	t_{hp}	1	1	-	t_{DCLK}	
Vertical Period	t_v	-	312	-	t_h	
Vertical Display Period	t_{vd}	288	288	288	t_h	
Vertical Back Porch	t_{vb}	2	24	-	t_h	
Vertical Pulse Width	t_{vp}	1	1	-	t_h	
Data setup time	t_{su}	12	-	-	ns	
Data hold time	t_{hold}	12	-	-	ns	

320 (NTSC) Mode timing specifications:

Parameter	Symbol	Min.	Typ.	Max.	Unit.	Note
DCLK Frequency	$1/t_{DCLK}$	-	24.535	-	MHz	
Horizontal Period	t_h	-	1560	-	t_{DCLK}	
Horizontal Display Period	t_{hd}	1280	1280	1280	t_{DCLK}	
Horizontal Back Porch	t_{hb}	2	241	-	t_{DCLK}	
Horizontal Front Porch	t_{hf}	2	39	-	t_{DCLK}	
Horizontal Pulse Width	t_{hp}	1	1	-	t_{DCLK}	
Vertical Period	t_v	-	262.5	-	t_h	
Vertical Display Period	t_{vd}	240	240	240	t_h	
Vertical Back Porch	t_{vb}	2	21	-	t_h	
Vertical Pulse Width	t_{vp}	1	1	-	t_h	
Data setup time	t_{su}	12	-	-	ns	
Data hold time	t_{hold}	12	-	-	ns	

320 (PAL) Mode timing specifications:

Parameter	Symbol	Min.	Typ.	Max.	Unit.	Note
DCLK Frequency	$1/t_{DCLK}$	-	24.375	-	MHz	
Horizontal Period	t_h	-	1560	-	t_{DCLK}	
Horizontal Display Period	t_{hd}	1280	1280	1280	t_{DCLK}	
Horizontal Back Porch	t_{hb}	2	241	-	t_{DCLK}	
Horizontal Front Porch	t_{hf}	2	39	-	t_{DCLK}	
Horizontal Pulse Width	t_{hp}	1	1	-	t_{DCLK}	
Vertical Period	t_v	-	312.5	-	t_h	
Vertical Display Period	t_{vd}	288	288	288	t_h	
Vertical Back Porch	t_{vb}	2	24	-	t_h	
Vertical Pulse Width	t_{vp}	1	1	-	t_h	
Data setup time	t_{su}	12	-	-	ns	
Data hold time	t_{hold}	12	-	-	ns	

6.1.5. 24-bit Parallel RGB Interface

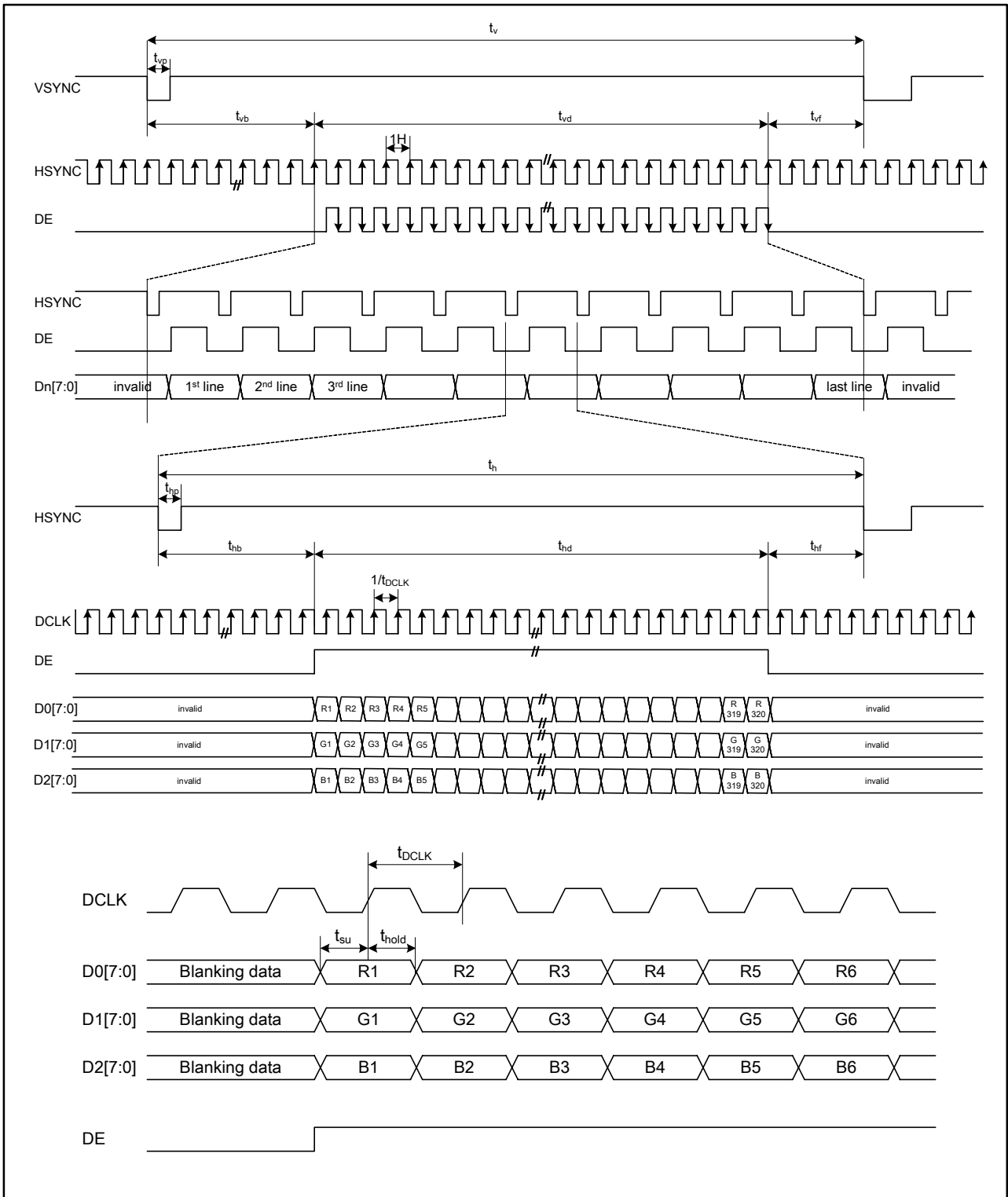

Figure6 Parallel RGB Input Signal Timing

Parameter	Symbol	Min.	Typ.	Max.	Unit.	Note
DCLK Frequency	$1/t_{DCLK}$	-	6.4	11	MHz	
Horizontal Period	t_h	-	408	-	t_{DCLK}	
Horizontal Display Period	t_{hd}	320	320	320	t_{DCLK}	
Horizontal Back Porch	t_{hb}	2	38	-	t_{DCLK}	
Horizontal Front Porch	t_{hf}	2	-	-	t_{DCLK}	
Horizontal Pulse Width	t_{hp}	1	1	-	t_{DCLK}	
Vertical Period	t_v	-	262	-	t_h	
Vertical Display Period	t_{vd}	240	240	240	t_h	
Vertical Back Porch	t_{vb}	2	18	-	t_h	
Vertical Front Porch	t_{vf}	2	4	-	t_h	
Vertical Pulse Width	t_{vp}	1	1	-	t_h	
Data setup time	t_{su}	12	-	-	ns	
Data hold time	t_{hold}	12	-	-	ns	

6.2. Serial Peripheral Interface (SPI)

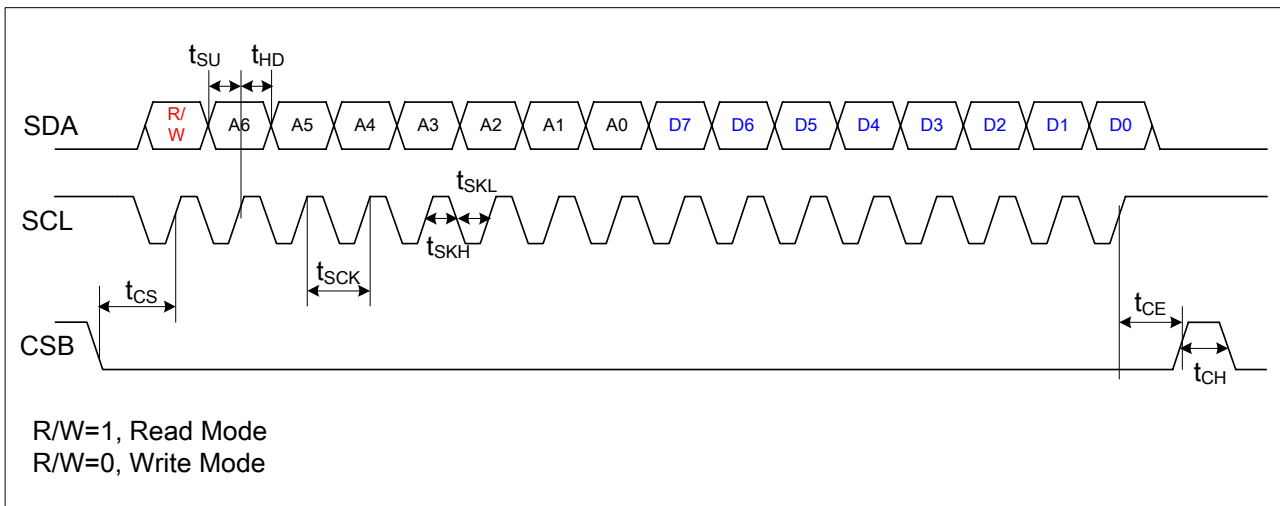

Figure7 SPI Interface Input Signal Timing

SPI Timing Specification

Items	Symbol	Min.	Typ.	Max.	Unit	Note
CSB to SCL Setup time	T_{CS}	50	-	-	ns	
CSB to SCL Hold time	T_{CE}	50	-	-	ns	
SCL Period	T_{SCK}	50	-	-	ns	
SCL High Period	T_{SKH}	25	-	-	ns	
SCL Low Period	T_{SKL}	25	-	-	ns	
Data Setup Time	T_{SU}	15	-	-	ns	
Data Hold Time	T_{HD}	15	-	-	ns	
CSB High Pulse Period	T_{CH}	50	-	-	ns	

7. Register

NO.	Description	D7	D6	D5	D4	D3	D2	D1	D0
R00	Chip ID	1	0	0	1	0	0	1	1
R01	VCOM Amplitude	-	-	-	VDV[4]	VDV[3]	VDV[2]	VDV[1]	VDV[0]
R02	VCOM High Voltage	-	-	VCM[5]	VCM[4]	VCM[3]	VCM[2]	VCM[1]	VCM[0]
R03	VREG1OUT Voltage	-	-	-	VREG[4]	VREG[3]	VREG[2]	VREG[1]	VREG[0]
R04	Global Reset	-	-	-	-	-	-	-	GRESET
R05	Power Setting	-	VC[2]	VC[1]	VC[0]	-	BT[2]	BT[1]	BT[0]
R06	Entry Control	IN_SEL[3]	IN_SEL[2]	IN_SEL[1]	IN_SEL[0]	NTPAL[1]	NTPAL[0]	VDIR	HDIR
R07	Power Control	AUTO_EN	VCL_EN	VCOM_EN	-	DDVDH_EN	VGH_EN	VGL_EN	STB
R08	Vertical Back Porch	-	-	VBP[5]	VBP[4]	VBP[3]	VBP[2]	VBP[1]	VBP[0]
R09	Horizontal Back Porch	HBP[7]	HBP[6]	HBP[5]	HBP[4]	HBP[3]	HBP[2]	HBP[1]	HBP[0]
R0A	Polarity	-	REV	Formula	CbCr/BGR	DE_POL	VS_POL	HS_POL	DK_POL
R0B	Display	-	-	-	-	RGBIF[1]	RGBIF[0]	-	F/L
R0C	DC/DC	-	DC2[2]	DC2[1]	DC2[0]	-	DC1[2]	DC1[1]	DC1[0]
R0D	Driving	-	AP[1]	AP[0]	-	GAP[1]	GAP[0]	SAP[1]	SAP[0]
R0E	CONTRAST	-	-	-	-	CONTRAST[3:0]			
R0F	BRIGHT	BRIGHTNESS[7:0]							
R10	Gamma1	Neg_Gamma_1[3:0]				Pos_Gamma_1[3:0]			
R11	Gamma2	Neg_Gamma_2[3:0]				Pos_Gamma_2[3:0]			
R12	Gamma3	Neg_Gamma_3[3:0]				Pos_Gamma_3[3:0]			
R13	Gamma4	Neg_Gamma_4[3:0]				Pos_Gamma_4[3:0]			
R14	Gamma5	Neg_Gamma_5[3:0]				Pos_Gamma_5[3:0]			
R15	Gamma6	Neg_Gamma_6[3:0]				Pos_Gamma_6[3:0]			
R16	Gamma7	Neg_Gamma_7[3:0]				Pos_Gamma_7[3:0]			
R17	Gamma8	Neg_Gamma_8[3:0]				Pos_Gamma_8[3:0]			
R30	Power	-	POL_OUT	-	-	AUTO_DP	DISP_ON	A_TIME[1]	A_TIME[0]
R42	OTP Program	OTP_PGM_EN	VCM_EN	VCM_OTP5	VCM_OTP4	VCM_OTP3	VCM_OTP2	VCM_OTP1	VCM_OTP0
R43	OTP Status	PGM_CNT1	PGM_CNT0	VCM_D5	VCM_D4	VCM_D3	VCM_D2	VCM_D1	VCM_D0
R44	OTP Key	OTP_KEY7	OTP_KEY6	OTP_KEY5	OTP_KEY4	OTP_KEY3	OTP_KEY2	OTP_KEY1	OTP_KEY0

7.1. Register Description

7.1.1. Device ID (R00h)

R/W	D7	D6	D5	D4	D3	D2	D1	D0
R	1	0	0	1	0	1	1	0

When reading this register, the Chip_ID will be read back (0x96).

7.1.2. VCOM AC Voltage (R01h)

R/W	D7	D6	D5	D4	D3	D2	D1	D0
W	0	0	0	VDV[4]	VDV[3]	VDV[2]	VDV[1]	VDV[0]

VDV[4:0] Select the factor of VREG1OUT to set the amplitude of Vcom alternating voltage from 0.70 to 1.32 x VREG1OUT.

VDV[4:0]	VCOM Amplitude	VDV[4:0]	VCOM Amplitude
5'h00	VREG1OUT x 0.70	5'h10	VREG1OUT x 1.02
5'h01	VREG1OUT x 0.72	5'h11	VREG1OUT x 1.04
5'h02	VREG1OUT x 0.74	5'h12	VREG1OUT x 1.06
5'h03	VREG1OUT x 0.76	5'h13	VREG1OUT x 1.08
5'h04	VREG1OUT x 0.78	5'h14	VREG1OUT x 1.10
5'h05	VREG1OUT x 0.80	5'h15	VREG1OUT x 1.12
5'h06	VREG1OUT x 0.82	5'h16	VREG1OUT x 1.14
5'h07	VREG1OUT x 0.84	5'h17	VREG1OUT x 1.16
5'h08	VREG1OUT x 0.86	5'h18	VREG1OUT x 1.18
5'h09	VREG1OUT x 0.88	5'h19	VREG1OUT x 1.20
5'h0a	VREG1OUT x 0.90	5'h1a	VREG1OUT x 1.22
5'h0b	VREG1OUT x 0.92	5'h1b	VREG1OUT x 1.24
5'h0c	VREG1OUT x 0.94	5'h1c	VREG1OUT x 1.26
5'h0d	VREG1OUT x 0.96	5'h1d	VREG1OUT x 1.28
5'h0e	VREG1OUT x 0.98	5'h1e	VREG1OUT x 1.30
5'h0f	VREG1OUT x 1.00 (Default)	5'h1f	VREG1OUT x 1.32

7.1.3. VCOM High Voltage (R02h)

R/W	D7	D6	D5	D4	D3	D2	D1	D0
W	0	0	VCM[5]	VCM[4]	VCM[3]	VCM[2]	VCM[1]	VCM[0]

VCM[5:0] Set the VCOMH voltage from 0.37 to 1.00 x VREG1OUT.

VCM[5:0]	VCOMH	VCM[5:0]	VCOMH
6'h00	VREG1OUT x 0.37	6'h20	VREG1OUT x 0.69
6'h01	VREG1OUT x 0.38	6'h21	VREG1OUT x 0.70
6'h02	VREG1OUT x 0.39	6'h22	VREG1OUT x 0.71
6'h03	VREG1OUT x 0.40	6'h23	VREG1OUT x 0.72
6'h04	VREG1OUT x 0.41	6'h24	VREG1OUT x 0.73
6'h05	VREG1OUT x 0.42	6'h25	VREG1OUT x 0.74
6'h06	VREG1OUT x 0.43	6'h26	VREG1OUT x 0.75
6'h07	VREG1OUT x 0.44	6'h27	VREG1OUT x 0.76
6'h08	VREG1OUT x 0.45	6'h28	VREG1OUT x 0.77
6'h09	VREG1OUT x 0.46	6'h29	VREG1OUT x 0.78
6'h0a	VREG1OUT x 0.47	6'h2a	VREG1OUT x 0.79

The information contained herein is the exclusive property of ILI Technology Corp. and shall not be distributed, reproduced, or disclosed in whole or in part without prior written permission of ILI Technology Corp.

6'h0b	VREG1OUT x 0.48	6'h2b	VREG1OUT x 0.80
6'h0c	VREG1OUT x 0.49	6'h2c	VREG1OUT x 0.81
6'h0d	VREG1OUT x 0.50	6'h2d	VREG1OUT x 0.82
6'h0e	VREG1OUT x 0.51	6'h2e	VREG1OUT x 0.83 (Default)
6'h0f	VREG1OUT x 0.52	6'h2f	VREG1OUT x 0.84
6'h10	VREG1OUT x 0.53	6'h30	VREG1OUT x 0.85
6'h11	VREG1OUT x 0.54	6'h31	VREG1OUT x 0.86
6'h12	VREG1OUT x 0.55	6'h32	VREG1OUT x 0.87
6'h13	VREG1OUT x 0.56	6'h33	VREG1OUT x 0.88
6'h14	VREG1OUT x 0.57	6'h34	VREG1OUT x 0.89
6'h15	VREG1OUT x 0.58	6'h35	VREG1OUT x 0.90
6'h16	VREG1OUT x 0.59	6'h36	VREG1OUT x 0.91
6'h17	VREG1OUT x 0.60	6'h37	VREG1OUT x 0.92
6'h18	VREG1OUT x 0.61	6'h38	VREG1OUT x 0.93
6'h19	VREG1OUT x 0.62	6'h39	VREG1OUT x 0.94
6'h1a	VREG1OUT x 0.63	6'h3a	VREG1OUT x 0.95
6'h1b	VREG1OUT x 0.64	6'h3b	VREG1OUT x 0.96
6'h1c	VREG1OUT x 0.65	6'h3c	VREG1OUT x 0.97
6'h1d	VREG1OUT x 0.66	6'h3d	VREG1OUT x 0.98
6'h1e	VREG1OUT x 0.67	6'h3e	VREG1OUT x 0.99
6'h1f	VREG1OUT x 0.68	6'h3f	VREG1OUT x 1.00

7.1.4. VREG1OUT Voltage (R03h)

R/W	D7	D6	D5	D4	D3	D2	D1	D0
W	0	0	0	VREG[4]	VREG[3]	VREG[2]	VREG[1]	VREG[0]

VREG[4:0] Set the voltage level of VREG1OUT, which is a reference level for the VCOM level and the grayscale voltage level.

VREG [4:0]	VREG1OUT (Volt)	VREG [4:0]	VREG1OUT (Volt)
00000	3.6	10000	5.2
00001	3.7	10001	5.3
00010	3.8	10010	5.4 (default)
00011	3.9	10011	5.5
00100	4	10100	5.6
00101	4.1	10101	5.7
00110	4.2	10110	5.8
00111	4.3	10111	5.9
01000	4.4	11000	6.0
01001	4.5	11001	-
01010	4.6	11010	-
01011	4.7	11011	-
01100	4.8	11100	-
01101	4.9	11101	-
01110	5.0	11110	-
01111	5.1	11111	-

7.1.5. Global Reset (R04h)

R/W	D7	D6	D5	D4	D3	D2	D1	D0
-----	----	----	----	----	----	----	----	----

W	0	0	0	0	0	0	0	0	GRESET
---	---	---	---	---	---	---	---	---	--------

Global reset signal control register.

GRESET	Description
1	Normal operation (Default)
0	Reset all the register value to the default value.

7.1.6. Power Setting 1 (R05h)

R/W	D7	D6	D5	D4	D3	D2	D1	D0
W	0	VC[2]	VC[1]	VC[0]	0	BT[2]	BT[1]	BT[0]

BT[3:0]: Sets the factor used in the step-up circuits. Select the optimal step-up factor for the operating voltage. To reduce power consumption, set a smaller factor.

BT[2]	BT[1]	BT[0]	DDVDH	VCL	VGH	VGL
0	0	0	2 x VCI1	-1 x VCI1	6 x VCI1	-5 x VCI1
0	0	1	2 x VCI1	-1 x VCI1	6 x VCI1	-4 x VCI1
0	1	0	2 x VCI1	-1 x VCI1	6 x VCI1	-3 x VCI1 (default)
0	1	1	2 x VCI1	-1 x VCI1	5 x VCI1	-5 x VCI1
1	0	0	2 x VCI1	-1 x VCI1	5 x VCI1	-4 x VCI1
1	0	1	2 x VCI1	-1 x VCI1	5 x VCI1	-3 x VCI1
1	1	0	2 x VCI1	-1 x VCI1	4 x VCI1	-4 x VCI1
1	1	1	2 x VCI1	-1 x VCI1	4 x VCI1	-3 x VCI1

VC[2:0] Sets the ratio factor of VCI to generate the reference voltages VCI1

VC[2]	VC[1]	VC[0]	VCI1
0	0	0	VCI1=VCI × 1.00
0	0	1	VCI1=VCI × 0.95
0	1	0	VCI1=VCI × 0.90 (Default)
0	1	1	VCI1=VCI × 0.85
1	0	0	VCI1=VCI × 0.80
1	0	1	VCI1=VCI × 0.75
1	1	0	VCI1=VCI × 0.70
1	1	1	Disable

7.1.7. Entry Control (R06h)

R/W	D7	D6	D5	D4	D3	D2	D1	D0
W	IN_SEL[3]	IN_SEL[2]	IN_SEL[1]	IN_SEL[0]	NTPAL[1]	NTPAL[0]	VDIR	HDIR

HDIR	Description
1	Left-to-Right scan (default)
0	Right-to-Left scan

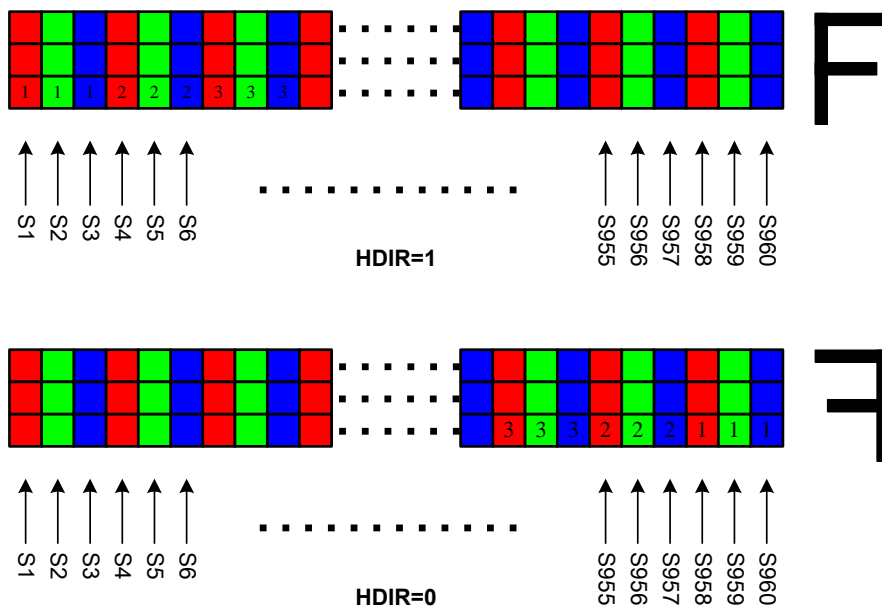

VDIR	Description
1	Up-to-down scan (default)
0	Down-to-up scan



NTPAL[1:0]	Description
00	NTSC mode
01	PAL mode
10	Not defined
11	Auto-Detection (default)

IN_SEL[3:0]	Description
0000	Serial RGB interface (through mode) Input data must be aligned with the color filter arrangement.
0001	Serial RGB interface (alignment mode) Input data must always be the R1, G1, B1, R2, G2, B2, ... sequence, and the R/G/B data will be swapped automatically based on the selected color filter arrangement.
0010	Serial RGB Dummy interface (320x240 Mode)
0011	Serial RGB Dummy interface (360x240 Mode)
0100	Setting disable
0101	Parallel RGB Interface (through mode) Input data must be aligned with the color filter arrangement.
0110	Parallel RGB Interface (alignment mode) Input data always follows the D0[7:0]=R, D1[7:0]=G, D2[7:0]= B sequence, and the R/G/B data will be swapped automatically based on the selected color filter arrangement, VDIR,

	and HDIR.
0111	YUV Mode 640Y, 320CbCr 24.54MHz Data format
1000	YUV Mode 720Y, 360CbCr 27MHz Data format
1001	Setting disable
1010	ITU-R BT.656 interface (720Y 360CbCr 27Mhz)
1011	ITU-R BT.656 interface (640Y 320CbCr 27Mhz)

Note:

- The default value of IN_SEL[3:0] is dependent on the IF[2:1] status

IF2	IF1	MPU-Interface Mode	IN_SEL[3:0] Default value
0	0	8-bit Serial RGB Interface	0000
0	1	24-bit Parallel RGB Interface	0101
1	0	ITU-R BT.601	1000
1	1	ITU-R BT.656	1010

7.1.8. Power Control (R07h)

R/W	D7	D6	D5	D4	D3	D2	D1	D0
W	Auto_EN	VCL_EN	VCOM_EN	-	DDVDH_EN	VGH_EN	VGL_EN	STB

STB	Description
0	Standby mode
1	Normal operation (default)

VGL_EN	Description
0	VGL power off
1	VGL power on (default)

VGH_EN	Description
0	VGH power off
1	VGH power on (default)

DDVDH_EN	Description
0	DDVDH power off
1	DDVDH power on (default)

VCOM_EN	Description
0	VCOM power off
1	VCOM power on (default)

VCL_EN	Description
0	VCL power off
1	VCL power on (default)

Auto_EN	Description
0	Manual power on sequence
1	Auto power on sequence (default)

7.1.9. Back Porch Control (R08h, R09h)

R/W	D7	D6	D5	D4	D3	D2	D1	D0
W	0	0	VBP[5]	VBP[4]	VBP[3]	VBP[2]	VBP[1]	VBP[0]
W	HBP[7]	HBP[6]	HBP[5]	HBP[4]	HBP[3]	HBP[2]	HBP[1]	HBP[0]

VBP (Vertical Back Porch)

VBP[5:0]	Vertical Back Porch	UNIT
00h	1	Line
...	..	
10h	17	
11h	18 (default)	
12h	19	
...	..	
3Fh	64	

HBP (Horizontal Back Porch)

HBP[7:0]	Horizontal Back Porch	UNIT
00h	TP-128	DCLK
...	..	
7Fh	TP-1	
80h	Typical value (TP, default)	
81h	TP+1	
...	..	
FFh	TP+127	

Note: Typical value is listed in each interface table.

7.1.10. Polarity Control (R0Ah)

R/W	D7	D6	D5	D4	D3	D2	D1	D0
W	0	REV	Formula	CbCr/BGR	DE_POL	VS_POL	HS_POL	DK_POL

DCLK_POL	Function
0	Negative Polarity
1	Positive Polarity (default)

VSYNC_POL	Function
0	Negative Polarity (default)
1	Positive Polarity

HSYNC_POL	Function
0	Negative Polarity (default)
1	Positive Polarity

DE_POL	Function
0	Negative Polarity
1	Positive Polarity (default)

CbCr/BGR	Function
0	YCbCr Mode: Cb0, Y0, Cr0, Y1, Cb2, Y2, Cr2, Y3 (default)

	RGB mode: R, G, B, R, G, B
1	YCbCr Mode: Cr0, Y0, Cb0, Y1, Cr2, Y2, Cb2, Y3 RGB mode: B, G, R, B, G, R

Note: This bit is invalid for the through mode.

Formula	Description
0	Formula A (default)
1	Formula B

RGB – YCbCr Equations Formula A:

$$R = Y + 1.371 * (Cr - 128)$$

$$G = Y - 0.698 * (Cr - 128) - 0.336 * (Cb - 128)$$

$$B = Y + 1.732 * (Cb - 128)$$

Where Y: 16 ~ 235, Cr: 16 ~ 240, Cb: 16 ~ 240

RGB – YCbCr Equations Formula B:

$$R = 1.164 * (Y - 16) + 1.596 * (Cr - 128)$$

$$G = 1.164 * (Y - 16) - 0.813 * (Cr - 128) - 0.392 * (Cb - 128)$$

$$B = 1.164 * (Y - 16) + 2.017 * (Cb - 128)$$

Where Y: 0 ~ 255, Cr: 0 ~ 255, Cb: 0 ~ 255

REV	GRAM Data	Source Output in Display Area	
		Positive polarity	negative polarity
0	24'h000000	V255	V0
	.	.	.
	.	.	.
	24'hFFFFFF	V0	V255
1 (Default)	24'h000000	V0	V255
	.	.	.
	.	.	.
	24'hFFFFFF	V255	V0

7.1.11. Interface Control (R0Bh)

R/W	D7	D6	D5	D4	D3	D2	D1	D0
W	0	0	0	0	RGBIF[1]	RGBIF[0]	0	F/L

F/L	Function
0	Frame inversion.
1	Line Inversion. (default)

RGBIF[1:0]	Function
00	HSYNC+VSYNC Mode
01	HSYNC+VSYNC+DE Mode (default)
10	DE Only Mode
11	Setting disabled

7.1.12. Power Control 1 (R0Ch)

R/W	D7	D6	D5	D4	D3	D2	D1	D0
W	0	DC2[2]	DC2[1]	DC2[0]	0	DC1[2]	DC1[1]	DC1[0]

DC0[2:0]: Selects the operating frequency of the step-up circuit 1. The higher step-up operating frequency enhances the drivability of the step-up circuit and the quality of display but increases the current consumption. Adjust the frequency taking the trade-off between the display quality and the current consumption into account.

DC1[2]	DC1[1]	DC1[0]	Frequency
0	0	0	DCLK/8
0	0	1	DCLK/16
0	1	0	DCLK/32
0	1	1	DCLK/64
1	0	0	DCLK/128 (Default)
1	0	1	DCLK/256
1	1	0	DCLK/512
1	1	1	Disable

DC1[2:0]: Selects the operating frequency of the step-up circuit 2. The higher step-up operating frequency enhances the drivability of the step-up circuit and the quality of display but increases the current consumption. Adjust the frequency taking the trade-off between the display quality and the current consumption into account.

DC2[2]	DC2[1]	DC2[0]	Frequency
0	0	0	DCLK/32
0	0	1	DCLK/64
0	1	0	DCLK/128
0	1	1	DCLK/256
1	0	0	DCLK/512 (Default)
1	0	1	DCLK/1024
1	1	0	DCLK/2048
1	1	1	Disable

Note: Be sure $f_{DCDC1} \geq f_{DCDC2}$ when setting DC0[2:0] and DC1[2:0].

7.1.13. Power Control 2(R0Dh)

R/W	D7	D6	D5	D4	D3	D2	D1	D0
W	0	AP[1]	AP[0]	0	GAP[1]	GAP[1]	SAP[1]	SAP[0]

AP[1]	AP[0]	Driving Current
0	0	X1.0 (Default)
0	1	X0.75
1	0	X1.25
1	1	X 1.5

GAP[1]	GAP[0]	Driving Current
0	0	X0.8
0	1	X0.9
1	0	X1.0 (Default)

1	1	X 1.1
<hr/>		
SAP[1]	SAP[0]	Driving Current
0	0	X0.8
0	1	X0.9
1	0	X1.0 (Default)
1	1	X 1.1

7.1.14. Contrast Control (R0Eh)

R/W	D7	D6	D5	D4	D3	D2	D1	D0
W	0	0	0	0	Contrast[3]	Contrast[2]	Contrast[1]	Contrast[0]

Contrast[3:0]	Contrast Gain (0.125/LSB)
0000	Setting disable
...	...
1000	1 (default)
...	...
1111	1.875

Output data value for display = input data value * contrast[3:0] + brightness[7:0]

7.1.15. Brightness Control (R0Fh)

R/W	D7	D6	D5	D4	D3	D2	D1	D0
W	Brightness [7:0]							

Brightness [7:0]	Brightness Value
00000000	-128
...	...
10000000	0 (default)
...	...
11111111	127

Output data value for display = input data value * contrast[3:0] + brightness[7:0]

7.1.16. Power Control 2 (R30h)

R/W	D7	D6	D5	D4	D3	D2	D1	D0
W		POL_OUT			AUTO_DP	DISP_ON	A_TIME[1]	A_TIME[0]

POL_OUT	Description
0	POL and VCOM are in same phase (default)
1	POL and VCOM are in reverse phase

AUTO_DP	Description
---------	-------------

0	White image display time is decided by DISP_ON
1	White image display time is decided by A_TIME[1:0] (default)

DISP_ON	Description
	When AUTO_DP="0", and DISP_ON="1", the normal display image is shown and the White image period is terminated (Default DISP_ON="0").

A_Time[1]	A_Time[0]	White image display time
0	0	10 frames
0	1	20 frames (Default)
1	0	40 frames
1	1	80 frames

7.1.17. OTP Programming Data (R42h)

R/W	D7	D6	D5	D4	D3	D2	D1	D0
W	OTP_PGM_EN	VCM_EN	VCM_OTP5	VCM_OTP4	VCM_OTP3	VCM_OTP2	VCM_OTP1	VCM_OTP0

OTP_PGM_EN: OTP programming enable.

OTP_PGM_EN	Function
0	Disable OTP programming (default)
1	Enable OTP programming

When OTP_PGM_EN is set as '1' and the OTP_KEY="55", the **VCM_OTP[5:0]** data will be written into OTP. The OTP_PGM_EN bit must be set as '0' when not to program OTP.

VCM_OTP[5:0]: OTP programming data for VCOMH voltage, the voltage refers to VCM[5:0] value.

VCOM_EN: VCOMH voltage adjustment selection

VCOM_EN	Function
0	Use the VCM register to set the VCOMH voltage (default)
1	Use OTP data to set the VCOMH voltage

7.1.18. OTP Program Read Back Register (R43h)

R/W	D7	D6	D5	D4	D3	D2	D1	D0
W	PGM_CNT1	PGM_CNT0	VCM_D5	VCM_D4	VCM_D3	VCM_D2	VCM_D1	VCM_D0

PGM_CNT[1:0]: OTP programmed record. These bits are read only.

OTP_PGM_CNT[1:0]	Description
00	OTP clean (default)
01	OTP programmed 1 st time
10	OTP programmed 2 nd time
11	OTP programmed 3 rd times

Note that OTP can be programmed 3 times.

VCM_D[4:0]: OTP VCM data readback value. These bits are read only.

7.1.19. OTP Programming ID Key (R44h)

R/W	D7	D6	D5	D4	D3	D2	D1	D0
W	OTP_KEY7	OTP_KEY6	OTP_KEY5	OTP_KEY4	OTP_KEY3	OTP_KEY2	OTP_KEY1	OTP_KEY0

KEY[7:0]: OTP Programming ID key protection. Before writing OTP programming data R42h, R44h must be set as 0x55 to make OTP programming successfully. If R44h is not written with 0x55, OTP programming will be failed. See OTP Programming flow.

ILI9322 OTP Programming Flow

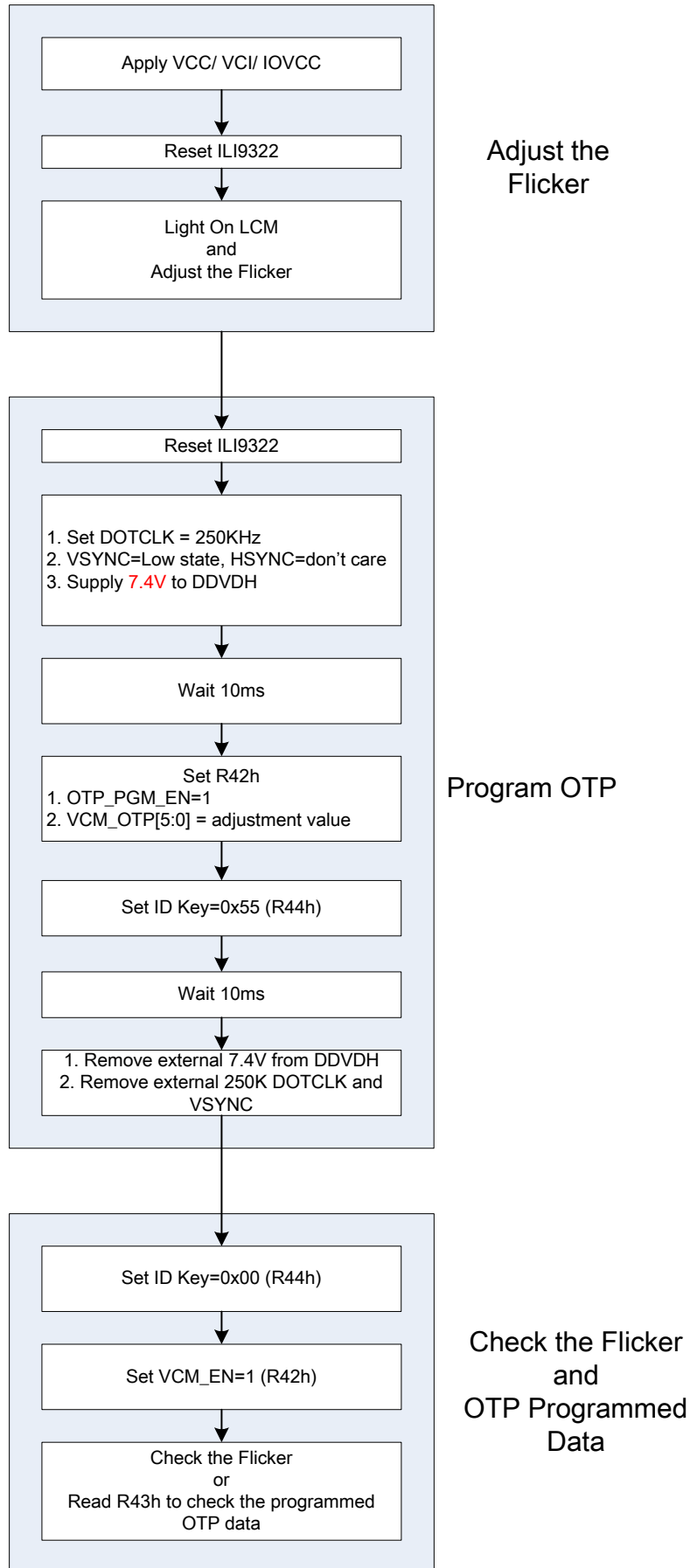

8. Color Filter Arrangement (CFA)

CF[2:1] and D/S pins define the color filter arrangement. If the serial RGB **through mode** interface are used, the input data sequence shall follow the color filter arrangement mapping.

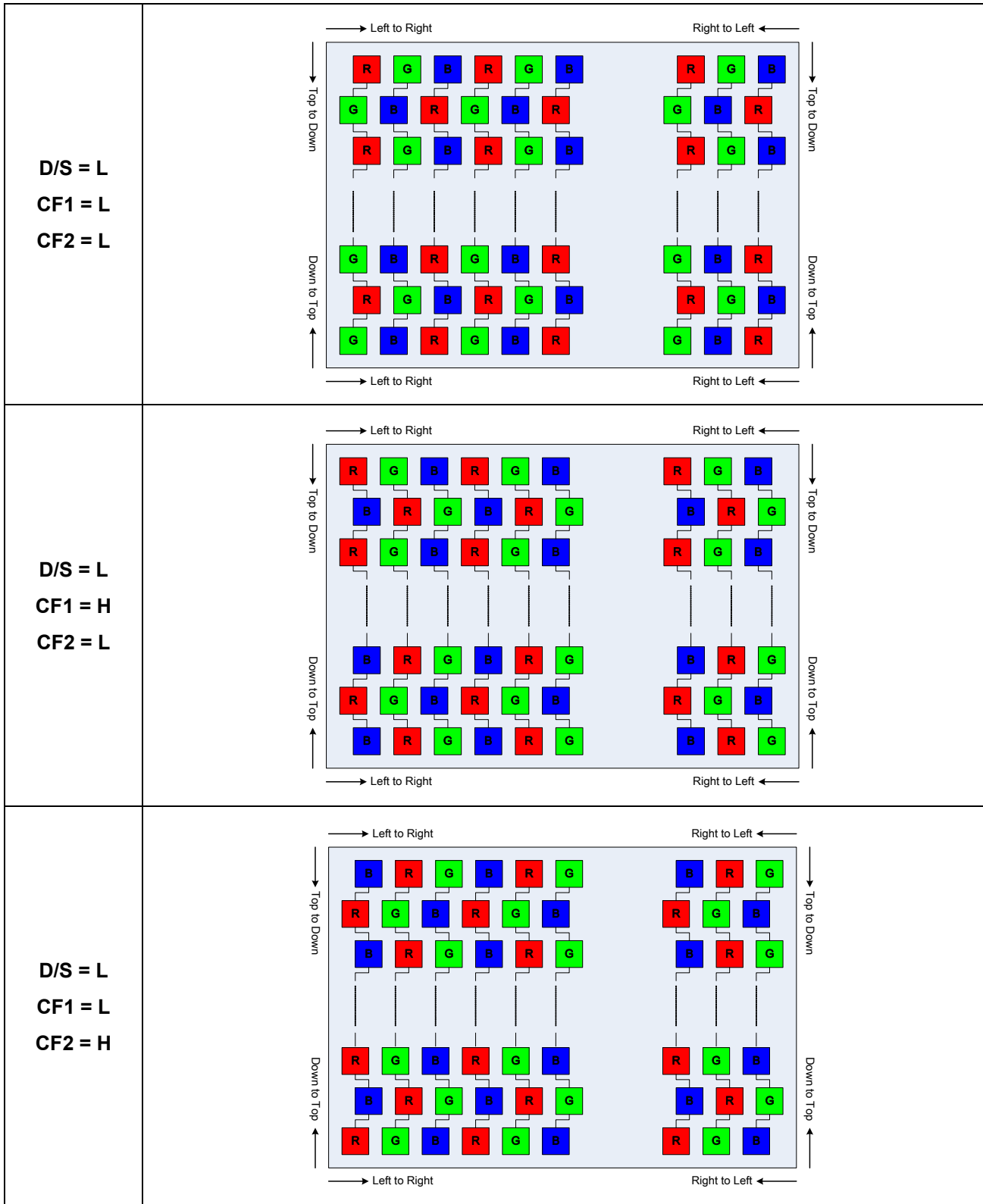

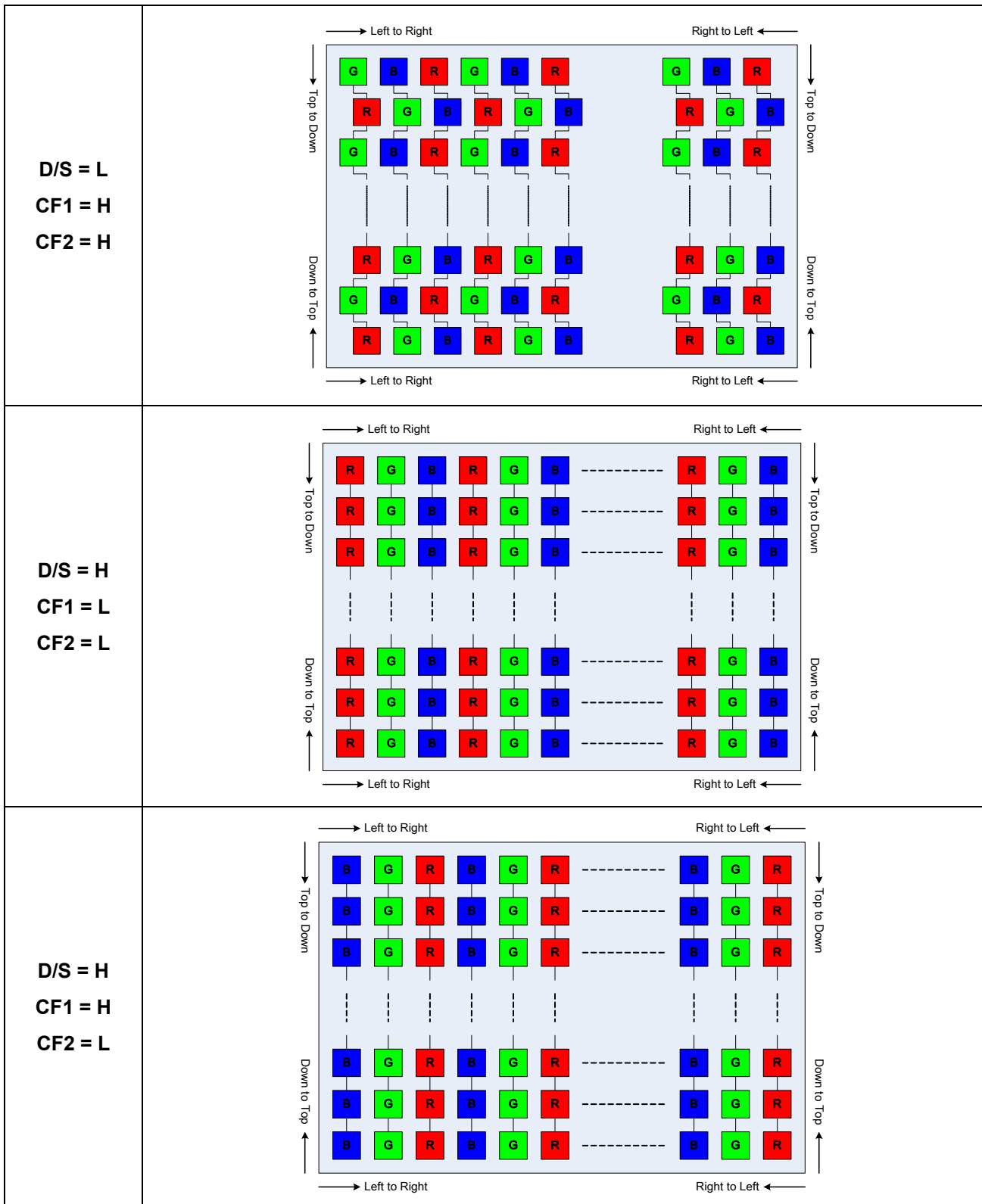

9. Gamma Correction

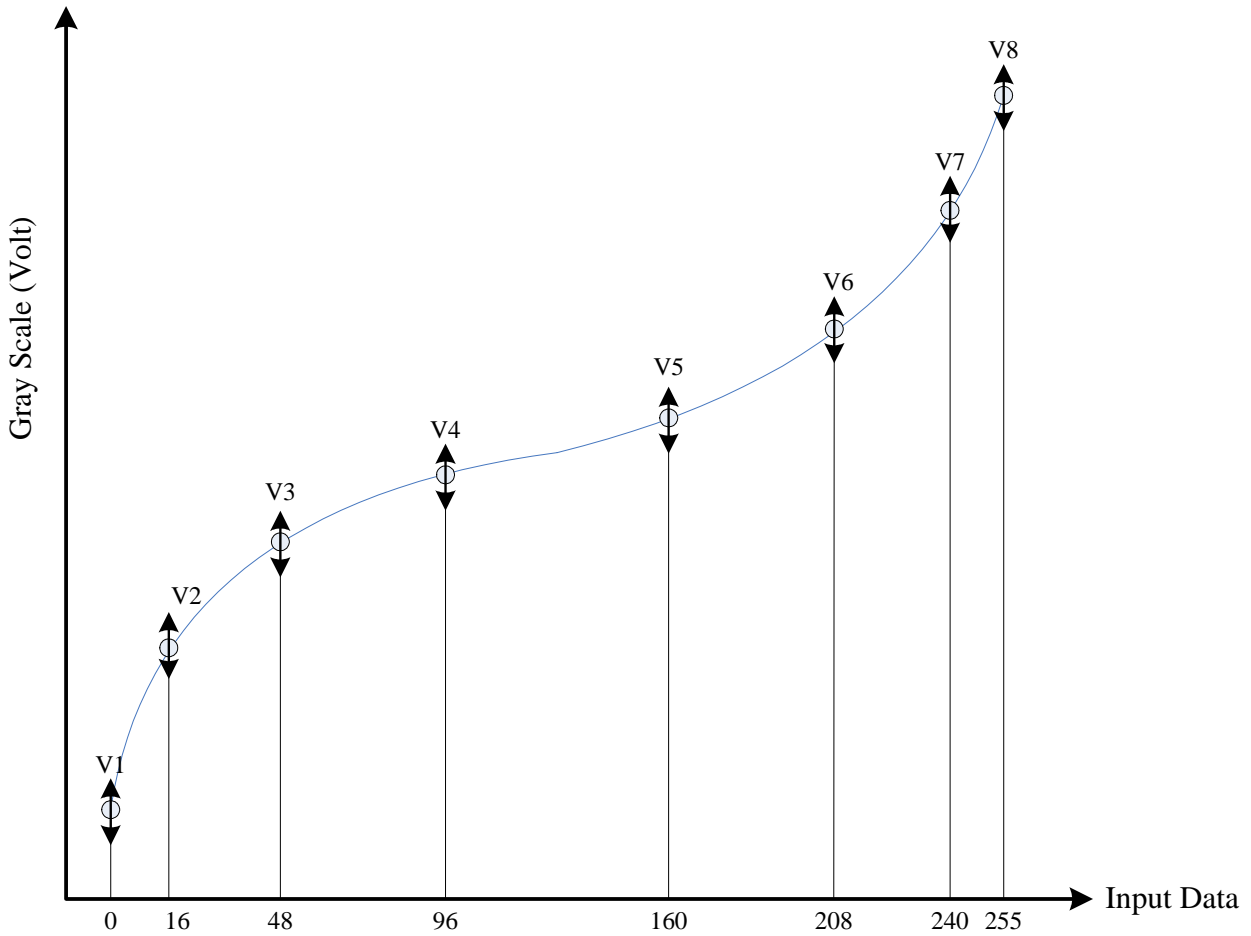

Neg_Gamma_x[3:0], x= 1 ~ 8	Pos_Gamma_x[3:0] X= 1 ~ 8	Percentage
0000	0000	× 0.79
0001	0001	× 0.82
0010	0010	× 0.85
0011	0011	× 0.88
0100	0100	× 0.91
0101	0101	× 0.94
0110	0110	× 0.97
0111	0111	× 1.00 (Default)
1000	1000	× 1.03
1001	1001	× 1.06
1010	1010	× 1.09
1011	1011	× 1.12
1100	1100	× 1.15
1101	1101	× 1.18
1110	1110	× 1.21
1111	1111	× 1.24

Default Gamma Value (VREG1OUT=4.5V, Neg_Gamma_x[3:0]="0111" and Pos_Gamma_x[3:0]="0111")

Data	Positive Polarity Gray Level	Voltage	Ohm	Formula
00H	VP0	4.450 (V1)	760	VP1
01H	VP1	4.253	760	VP2+(VP1-VP2)*9816/12180
02H	VP2	4.055	760	VP2+(VP1-VP2)*7440/12180
03H	VP3	3.858	760	VP2+(VP1-VP2)*5076/12180
04H	VP4	3.66	104	VP2+(VP1-VP2)*2700/12180
05H	VP5	3.633	104	VP2+(VP1-VP2)*2376/12180
06H	VP6	3.606	104	VP2+(VP1-VP2)*2052/12180
07H	VP7	3.579	104	VP2+(VP1-VP2)*1728/12180
08H	VP8	3.552	82	VP2+(VP1-VP2)*1404/12180
09H	VP9	3.531	82	VP2+(VP1-VP2)*1152/12180
0AH	VP10	3.51	82	VP2+(VP1-VP2)*900/12180
0BH	VP11	3.488	82	VP2+(VP1-VP2)*636/12180
0CH	VP12	3.467	63	VP2+(VP1-VP2)*384/12180
0DH	VP13	3.451	63	VP2+(VP1-VP2)*192/12180
0EH	VP14	3.435 (V2)	62	VP2
0FH	VP15	3.418	63	VP3+(VP2-VP3)*6768/6972
10H	VP16	3.402	52	VP3+(VP2-VP3)*6576/6972
11H	VP17	3.389	52	VP3+(VP2-VP3)*6420/6972
12H	VP18	3.375	52	VP3+(VP2-VP3)*6252/6972
13H	VP19	3.362	52	VP3+(VP2-VP3)*6096/6972
14H	VP20	3.348	50	VP3+(VP2-VP3)*5928/6972
15H	VP21	3.335	50	VP3+(VP2-VP3)*5772/6972
16H	VP22	3.322	50	VP3+(VP2-VP3)*5616/6972
17H	VP23	3.309	50	VP3+(VP2-VP3)*5460/6972
18H	VP24	3.296	40	VP3+(VP2-VP3)*5304/6972
19H	VP25	3.286	40	VP3+(VP2-VP3)*5184/6972
1AH	VP26	3.275	40	VP3+(VP2-VP3)*5052/6972
1BH	VP27	3.265	40	VP3+(VP2-VP3)*4932/6972
1CH	VP28	3.254	32	VP3+(VP2-VP3)*4800/6972
1DH	VP29	3.246	32	VP3+(VP2-VP3)*4704/6972
1EH	VP30	3.238	32	VP3+(VP2-VP3)*4608/6972
1FH	VP31	3.229	32	VP3+(VP2-VP3)*4500/6972
20H	VP32	3.221	36	VP3+(VP2-VP3)*4404/6972
21H	VP33	3.212	36	VP3+(VP2-VP3)*4296/6972
22H	VP34	3.203	36	VP3+(VP2-VP3)*4188/6972
23H	VP35	3.193	36	VP3+(VP2-VP3)*4068/6972
24H	VP36	3.184	29	VP3+(VP2-VP3)*3960/6972
25H	VP37	3.177	29	VP3+(VP2-VP3)*3876/6972
26H	VP38	3.169	29	VP3+(VP2-VP3)*3780/6972
27H	VP39	3.162	29	VP3+(VP2-VP3)*3696/6972
28H	VP40	3.154	29	VP3+(VP2-VP3)*3600/6972
29H	VP41	3.147	29	VP3+(VP2-VP3)*3516/6972
2AH	VP42	3.139	29	VP3+(VP2-VP3)*3420/6972
2BH	VP43	3.132	29	VP3+(VP2-VP3)*3336/6972
2CH	VP44	3.124	31	VP3+(VP2-VP3)*3240/6972
2DH	VP45	3.116	31	VP3+(VP2-VP3)*3144/6972
2EH	VP46	3.108	31	VP3+(VP2-VP3)*3048/6972
2FH	VP47	3.100	31	VP3+(VP2-VP3)*2952/6972
30H	VP48	3.092	25	VP3+(VP2-VP3)*2856/6972
31H	VP49	3.086	25	VP3+(VP2-VP3)*2784/6972
32H	VP50	3.079	25	VP3+(VP2-VP3)*2700/6972
33H	VP51	3.073	25	VP3+(VP2-VP3)*2628/6972

The information contained herein is the exclusive property of ILI Technology Corp. and shall not be distributed, reproduced, or disclosed in whole or in part without prior written permission of ILI Technology Corp.

Data	Positive Polarity Gray Level	Voltage	Ohm	Formula
34H	VP52	3.066	31	VP3+(VP2-VP3)*2544/6972
35H	VP53	3.058	31	VP3+(VP2-VP3)*2448/6972
36H	VP54	3.05	31	VP3+(VP2-VP3)*2352/6972
37H	VP55	3.042	31	VP3+(VP2-VP3)*2256/6972
38H	VP56	3.034	28	VP3+(VP2-VP3)*2160/6972
39H	VP57	3.027	28	VP3+(VP2-VP3)*2076/6972
3AH	VP58	3.02	28	VP3+(VP2-VP3)*1992/6972
3BH	VP59	3.012	28	VP3+(VP2-VP3)*1896/6972
3CH	VP60	3.005	24	VP3+(VP2-VP3)*1812/6972
3DH	VP61	2.999	24	VP3+(VP2-VP3)*1740/6972
3EH	VP62	2.993	24	VP3+(VP2-VP3)*1668/6972
3FH	VP63	2.986	24	VP3+(VP2-VP3)*1584/6972
40H	VP64	2.98	22	VP3+(VP2-VP3)*1512/6972
41H	VP65	2.974	22	VP3+(VP2-VP3)*1440/6972
42H	VP66	2.969	22	VP3+(VP2-VP3)*1380/6972
43H	VP67	2.963	22	VP3+(VP2-VP3)*1308/6972
44H	VP68	2.957	24	VP3+(VP2-VP3)*1236/6972
45H	VP69	2.951	24	VP3+(VP2-VP3)*1164/6972
46H	VP70	2.945	24	VP3+(VP2-VP3)*1092/6972
47H	VP71	2.938	24	VP3+(VP2-VP3)*1008/6972
48H	VP72	2.932	22	VP3+(VP2-VP3)*936/6972
49H	VP73	2.926	22	VP3+(VP2-VP3)*864/6972
4AH	VP74	2.921	22	VP3+(VP2-VP3)*804/6972
4BH	VP75	2.915	22	VP3+(VP2-VP3)*732/6972
4CH	VP76	2.909	25	VP3+(VP2-VP3)*660/6972
4DH	VP77	2.903	25	VP3+(VP2-VP3)*588/6972
4EH	VP68	2.896	25	VP3+(VP2-VP3)*504/6972
4FH	VP79	2.89	25	VP3+(VP2-VP3)*432/6972
50H	VP80	2.883	28	VP3+(VP2-VP3)*348/6972
51H	VP81	2.876	28	VP3+(VP2-VP3)*264/6972
52H	VP82	2.869	28	VP3+(VP2-VP3)*180/6972
53H	VP83	2.861	28	VP3+(VP2-VP3)*84/6972
54H	VP84	2.854 (V3)	19	VP3
55H	VP85	2.849	19	VP4+(VP3-VP4)*3708/3768
56H	VP86	2.844	19	VP4+(VP3-VP4)*3648/3768
57H	VP87	2.839	19	VP4+(VP3-VP4)*3588/3768
58H	VP88	2.834	24	VP4+(VP3-VP4)*3528/3768
59H	VP89	2.828	24	VP4+(VP3-VP4)*3456/3768
5AH	VP90	2.822	24	VP4+(VP3-VP4)*3384/3768
5BH	VP91	2.815	24	VP4+(VP3-VP4)*3300/3768
5CH	VP92	2.809	26	VP4+(VP3-VP4)*3228/3768
5DH	VP93	2.802	26	VP4+(VP3-VP4)*3144/3768
5EH	VP94	2.796	26	VP4+(VP3-VP4)*3072/3768
5FH	VP95	2.789	26	VP4+(VP3-VP4)*2988/3768
60H	VP96	2.782	23	VP4+(VP3-VP4)*2904/3768
61H	VP97	2.776	23	VP4+(VP3-VP4)*2832/3768
62H	VP98	2.77	23	VP4+(VP3-VP4)*2760/3768
63H	VP99	2.764	23	VP4+(VP3-VP4)*2688/3768
64H	VP100	2.758	24	VP4+(VP3-VP4)*2616/3768
65H	VP101	2.752	24	VP4+(VP3-VP4)*2544/3768
66H	VP102	2.746	24	VP4+(VP3-VP4)*2472/3768
67H	VP103	2.739	24	VP4+(VP3-VP4)*2388/3768
68H	VP104	2.733	25	VP4+(VP3-VP4)*2316/3768
69H	VP105	2.727	25	VP4+(VP3-VP4)*2244/3768

Data	Positive Polarity Gray Level	Voltage	Ohm	Formula
6AH	VP106	2.72	25	$VP4+(VP3-VP4)*2160/3768$
6BH	VP107	2.714	25	$VP4+(VP3-VP4)*2088/3768$
6CH	VP108	2.707	27	$VP4+(VP3-VP4)*2004/3768$
6DH	VP109	2.7	27	$VP4+(VP3-VP4)*1920/3768$
6EH	VP110	2.693	27	$VP4+(VP3-VP4)*1836/3768$
6FH	VP111	2.686	27	$VP4+(VP3-VP4)*1752/3768$
70H	VP112	2.679	21	$VP4+(VP3-VP4)*1668/3768$
71H	VP113	2.674	21	$VP4+(VP3-VP4)*1608/3768$
72H	VP114	2.668	21	$VP4+(VP3-VP4)*1536/3768$
73H	VP115	2.663	21	$VP4+(VP3-VP4)*1476/3768$
74H	VP116	2.657	23	$VP4+(VP3-VP4)*1404/3768$
75H	VP117	2.651	23	$VP4+(VP3-VP4)*1332/3768$
76H	VP118	2.645	23	$VP4+(VP3-VP4)*1260/3768$
77H	VP119	2.639	23	$VP4+(VP3-VP4)*1188/3768$
78H	VP120	2.633	30	$VP4+(VP3-VP4)*1116/3768$
79H	VP121	2.625	30	$VP4+(VP3-VP4)*1020/3768$
7AH	VP122	2.618	30	$VP4+(VP3-VP4)*936/3768$
7BH	VP123	2.61	30	$VP4+(VP3-VP4)*840/3768$
7CH	VP124	2.602	27	$VP4+(VP3-VP4)*744/3768$
7DH	VP125	2.595	27	$VP4+(VP3-VP4)*660/3768$
7EH	VP126	2.588	27	$VP4+(VP3-VP4)*576/3768$
7FH	VP127	2.581	27	$VP4+(VP3-VP4)*492/3768$
80H	VP128	2.574	26	$VP4+(VP3-VP4)*408/3768$
81H	VP129	2.567	26	$VP4+(VP3-VP4)*324/3768$
82H	VP130	2.561	26	$VP4+(VP3-VP4)*252/3768$
83H	VP131	2.554	26	$VP4+(VP3-VP4)*168/3768$
84H	VP132	2.547	29	$VP4+(VP3-VP4)*84/3768$
85H	VP133	2.540 (V4)	29	VP4
86H	VP134	2.532	29	$VP5+(VP4-VP5)*2772/2868$
87H	VP135	2.525	29	$VP5+(VP4-VP5)*2688/2868$
88H	VP136	2.517	30	$VP5+(VP4-VP5)*2592/2868$
89H	VP137	2.509	30	$VP5+(VP4-VP5)*2496/2868$
8AH	VP138	2.502	30	$VP5+(VP4-VP5)*2412/2868$
8BH	VP139	2.494	30	$VP5+(VP4-VP5)*2316/2868$
8CH	VP140	2.486	28	$VP5+(VP4-VP5)*2220/2868$
8DH	VP141	2.479	28	$VP5+(VP4-VP5)*2136/2868$
8EH	VP142	2.472	28	$VP5+(VP4-VP5)*2052/2868$
8FH	VP143	2.464	28	$VP5+(VP4-VP5)*1956/2868$
90H	VP144	2.457	27	$VP5+(VP4-VP5)*1872/2868$
91H	VP145	2.45	27	$VP5+(VP4-VP5)*1788/2868$
92H	VP146	2.443	27	$VP5+(VP4-VP5)*1704/2868$
93H	VP147	2.436	27	$VP5+(VP4-VP5)*1620/2868$
94H	VP148	2.429	24	$VP5+(VP4-VP5)*1536/2868$
95H	VP149	2.423	24	$VP5+(VP4-VP5)*1464/2868$
96H	VP150	2.417	24	$VP5+(VP4-VP5)*1392/2868$
97H	VP151	2.41	24	$VP5+(VP4-VP5)*1308/2868$
98H	VP152	2.404	32	$VP5+(VP4-VP5)*1236/2868$
99H	VP153	2.396	32	$VP5+(VP4-VP5)*1140/2868$
9AH	VP154	2.388	32	$VP5+(VP4-VP5)*1044/2868$
9BH	VP155	2.379	32	$VP5+(VP4-VP5)*936/2868$
9CH	VP156	2.371	37	$VP5+(VP4-VP5)*840/2868$
9DH	VP157	2.361	38	$VP5+(VP4-VP5)*720/2868$
9EH	VP158	2.352	37	$VP5+(VP4-VP5)*612/2868$
9FH	VP159	2.342	37	$VP5+(VP4-VP5)*492/2868$

The information contained herein is the exclusive property of ILI Technology Corp. and shall not be distributed, reproduced, or disclosed in whole or in part without prior written permission of ILI Technology Corp.

Data	Positive Polarity Gray Level	Voltage	Ohm	Formula
A0H	VP160	2.332	40	$VP5+(VP4-VP5)*372/2868$
A1H	VP161	2.322	40	$VP5+(VP4-VP5)*252/2868$
A2H	VP162	2.311	40	$VP5+(VP4-VP5)*120/2868$
A3H	VP163	2.301 (V5)	40	VP5
A4H	VP164	2.29	35	$VP6+(VP5-VP6)*2400/2532$
A5H	VP165	2.281	35	$VP6+(VP5-VP6)*2292/2532$
A6H	VP166	2.272	35	$VP6+(VP5-VP6)*2184/2532$
A7H	VP167	2.263	35	$VP6+(VP5-VP6)*2076/2532$
A8H	VP168	2.254	25	$VP6+(VP5-VP6)*1968/2532$
A9H	VP169	2.248	25	$VP6+(VP5-VP6)*1896/2532$
AAH	VP170	2.241	25	$VP6+(VP5-VP6)*1812/2532$
ABH	VP171	2.235	25	$VP6+(VP5-VP6)*1740/2532$
ACH	VP172	2.228	26	$VP6+(VP5-VP6)*1656/2532$
ADH	VP173	2.221	26	$VP6+(VP5-VP6)*1572/2532$
AEH	VP174	2.215	26	$VP6+(VP5-VP6)*1500/2532$
AFH	VP175	2.208	26	$VP6+(VP5-VP6)*1416/2532$
B0H	VP176	2.201	42	$VP6+(VP5-VP6)*1332/2532$
B1H	VP177	2.19	42	$VP6+(VP5-VP6)*1200/2532$
B2H	VP178	2.179	42	$VP6+(VP5-VP6)*1068/2532$
B3H	VP179	2.168	42	$VP6+(VP5-VP6)*936/2532$
B4H	VP180	2.157	39	$VP6+(VP5-VP6)*804/2532$
B5H	VP181	2.147	39	$VP6+(VP5-VP6)*684/2532$
B6H	VP182	2.137	39	$VP6+(VP5-VP6)*564/2532$
B7H	VP183	2.126	39	$VP6+(VP5-VP6)*432/2532$
B8H	VP184	2.116	34	$VP6+(VP5-VP6)*312/2532$
B9H	VP185	2.107	34	$VP6+(VP5-VP6)*204/2532$
BAH	VP186	2.099	34	$VP6+(VP5-VP6)*108/2532$
BBH	VP187	2.090 (V6)	34	VP6
BCH	VP188	2.081	33	$VP7+(VP6-VP7)*3162/3270$
BDH	VP189	2.073	33	$VP7+(VP6-VP7)*3066/3270$
BEH	VP190	2.064	33	$VP7+(VP6-VP7)*2958/3270$
BFH	VP191	2.056	33	$VP7+(VP6-VP7)*2862/3270$
C0H	VP192	2.047	48	$VP7+(VP6-VP7)*2754/3270$
C1H	VP193	2.035	48	$VP7+(VP6-VP7)*2610/3270$
C2H	VP194	2.022	48	$VP7+(VP6-VP7)*2454/3270$
C3H	VP195	2.01	48	$VP7+(VP6-VP7)*2310/3270$
C4H	VP196	1.997	48	$VP7+(VP6-VP7)*2154/3270$
C5H	VP197	1.985	48	$VP7+(VP6-VP7)*2010/3270$
C6H	VP198	1.972	48	$VP7+(VP6-VP7)*1854/3270$
C7H	VP199	1.96	48	$VP7+(VP6-VP7)*1710/3270$
C8H	VP200	1.947	48	$VP7+(VP6-VP7)*1554/3270$
C9H	VP201	1.935	48	$VP7+(VP6-VP7)*1410/3270$
CAH	VP202	1.922	48	$VP7+(VP6-VP7)*1254/3270$
CBH	VP203	1.91	48	$VP7+(VP6-VP7)*1110/3270$
CCH	VP204	1.897	62	$VP7+(VP6-VP7)*954/3270$
CDH	VP205	1.881	63	$VP7+(VP6-VP7)*762/3270$
CEH	VP206	1.865	62	$VP7+(VP6-VP7)*570/3270$
CFH	VP207	1.848	62	$VP7+(VP6-VP7)*366/3270$
D0H	VP208	1.832	54	$VP7+(VP6-VP7)*174/3270$
D1H	VP209	1.818 (V7)	54	VP7
D2H	VP210	1.810	54	$VP8+(VP7-VP8)*15121/15208$
D3H	VP211	1.803	54	$VP8+(VP7-VP8)*15034/15208$
D4H	VP212	1.795	57	$VP8+(VP7-VP8)*14946/15208$
D5H	VP213	1.788	57	$VP8+(VP7-VP8)*14858/15208$

Data	Positive Polarity Gray Level	Voltage	Ohm	Formula
D6H	VP214	1.780	57	$VP8+(VP7-VP8)*14769/15208$
D7H	VP215	1.772	57	$VP8+(VP7-VP8)*14680/15208$
D8H	VP216	1.764	75	$VP8+(VP7-VP8)*14587/15208$
D9H	VP217	1.756	75	$VP8+(VP7-VP8)*14492/15208$
DAH	VP218	1.748	75	$VP8+(VP7-VP8)*14396/15208$
DBH	VP219	1.739	75	$VP8+(VP7-VP8)*14300/15208$
DCH	VP220	1.731	94	$VP8+(VP7-VP8)*14203/15208$
DDH	VP221	1.722	94	$VP8+(VP7-VP8)*14106/15208$
DEH	VP222	1.714	94	$VP8+(VP7-VP8)*14008/15208$
DFH	VP223	1.706	94	$VP8+(VP7-VP8)*13910/15208$
E0H	VP224	1.697	87	$VP8+(VP7-VP8)*13811/15208$
E1H	VP225	1.688	88	$VP8+(VP7-VP8)*13711/15208$
E2H	VP226	1.680	87	$VP8+(VP7-VP8)*13611/15208$
E3H	VP227	1.671	87	$VP8+(VP7-VP8)*13510/15208$
E4H	VP228	1.661	90	$VP8+(VP7-VP8)*13391/15208$
E5H	VP229	1.650	90	$VP8+(VP7-VP8)*13265/15208$
E6H	VP230	1.639	90	$VP8+(VP7-VP8)*13138/15208$
E7H	VP231	1.628	90	$VP8+(VP7-VP8)*13010/15208$
E8H	VP232	1.616	115	$VP8+(VP7-VP8)*12882/15208$
E9H	VP233	1.605	115	$VP8+(VP7-VP8)*12753/15208$
EAH	VP234	1.594	115	$VP8+(VP7-VP8)*12623/15208$
EBH	VP235	1.583	115	$VP8+(VP7-VP8)*12493/15208$
ECH	VP236	1.571	148	$VP8+(VP7-VP8)*12362/15208$
EDH	VP237	1.558	148	$VP8+(VP7-VP8)*12210/15208$
EEH	VP238	1.544	148	$VP8+(VP7-VP8)*12046/15208$
EFH	VP239	1.530	148	$VP8+(VP7-VP8)*11881/15208$
F0H	VP240	1.515	183	$VP8+(VP7-VP8)*11716/15208$
F1H	VP241	1.501	183	$VP8+(VP7-VP8)*11550/15208$
F2H	VP242	1.487	183	$VP8+(VP7-VP8)*11383/15208$
F3H	VP243	1.472	183	$VP8+(VP7-VP8)*11215/15208$
F4H	VP244	1.453	148	$VP8+(VP7-VP8)*10997/15208$
F5H	VP245	1.431	148	$VP8+(VP7-VP8)*10746/15208$
F6H	VP246	1.409	148	$VP8+(VP7-VP8)*10494/15208$
F7H	VP247	1.387	148	$VP8+(VP7-VP8)*10240/15208$
F8H	VP248	1.365	128	$VP8+(VP7-VP8)*9985/15208$
F9H	VP249	1.330	128	$VP8+(VP7-VP8)*9575/15208$
FAH	VP250	1.294	128	$VP8+(VP7-VP8)*9160/15208$
FBH	VP251	1.255	128	$VP8+(VP7-VP8)*8716/15208$
FCH	VP252	1.205	71	$VP8+(VP7-VP8)*8131/15208$
FDH	VP253	1.143	71	$VP8+(VP7-VP8)*7420/15208$
FEH	VP254	0.975	71	$VP8+(VP7-VP8)*5476/15208$
FFH	VP255	0.500(V8)		VP8

Data	Negative Polarity Gray Level	Voltage	Ohm	Formula
00H	VN0	0.500 (V8)	760	VN8
01H	VN1	0.706	760	VN8+(VN7-VN8)*2376/15192
02H	VN2	0.911	760	VN8+(VN7-VN8)*4740/15192
03H	VN3	1.116	760	VN8+(VN7-VN8)*7116/15192
04H	VN4	1.321	104	VN8+(VN7-VN8)*9480/15192
05H	VN5	1.349	104	VN8+(VN7-VN8)*9804/15192
06H	VN6	1.377	104	VN8+(VN7-VN8)*10128/15192
07H	VN7	1.405	104	VN8+(VN7-VN8)*10452/15192
08H	VN8	1.433	82	VN8+(VN7-VN8)*10776/15192
09H	VN9	1.455	82	VN8+(VN7-VN8)*11028/15192
0AH	VN10	1.478	82	VN8+(VN7-VN8)*11292/15192
0BH	VN11	1.500	82	VN8+(VN7-VN8)*11544/15192
0CH	VN12	1.522	63	VN8+(VN7-VN8)*11796/15192
0DH	VN13	1.538	63	VN8+(VN7-VN8)*11988/15192
0EH	VN14	1.556	62	VN8+(VN7-VN8)*12192/15192
0FH	VN15	1.573	63	VN8+(VN7-VN8)*12384/15192
10H	VN16	1.589	52	VN8+(VN7-VN8)*12576/15192
11H	VN17	1.604	52	VN8+(VN7-VN8)*12744/15192
12H	VN18	1.617	52	VN8+(VN7-VN8)*12900/15192
13H	VN19	1.632	52	VN8+(VN7-VN8)*13068/15192
14H	VN20	1.646	50	VN8+(VN7-VN8)*13224/15192
15H	VN21	1.659	50	VN8+(VN7-VN8)*13380/15192
16H	VN22	1.673	50	VN8+(VN7-VN8)*13536/15192
17H	VN23	1.686	50	VN8+(VN7-VN8)*13692/15192
18H	VN24	1.700	40	VN8+(VN7-VN8)*13848/15192
19H	VN25	1.711	40	VN8+(VN7-VN8)*13980/15192
1AH	VN26	1.721	40	VN8+(VN7-VN8)*14100/15192
1BH	VN27	1.733	40	VN8+(VN7-VN8)*14232/15192
1CH	VN28	1.743	32	VN8+(VN7-VN8)*14352/15192
1DH	VN29	1.752	32	VN8+(VN7-VN8)*14448/15192
1EH	VN30	1.761	32	VN8+(VN7-VN8)*14556/15192
1FH	VN31	1.769	32	VN8+(VN7-VN8)*14652/15192
20H	VN32	1.778	36	VN8+(VN7-VN8)*14748/15192
21H	VN33	1.787	36	VN8+(VN7-VN8)*14856/15192
22H	VN34	1.797	36	VN8+(VN7-VN8)*14976/15192
23H	VN35	1.807	36	VN8+(VN7-VN8)*15084/15192
24H	VN36	1.816 (V7)	29	VN7
25H	VN37	1.824	29	VN7+(VN6-VN7)*96/3300
26H	VN38	1.831	29	VN7+(VN6-VN7)*180/3300
27H	VN39	1.839	29	VN7+(VN6-VN7)*276/3300
28H	VN40	1.846	29	VN7+(VN6-VN7)*360/3300
29H	VN41	1.854	29	VN7+(VN6-VN7)*456/3300
2AH	VN42	1.861	29	VN7+(VN6-VN7)*540/3300
2BH	VN43	1.869	29	VN7+(VN6-VN7)*636/3300
2CH	VN44	1.876	31	VN7+(VN6-VN7)*720/3300
2DH	VN45	1.884	31	VN7+(VN6-VN7)*816/3300
2EH	VN46	1.892	31	VN7+(VN6-VN7)*912/3300
2FH	VN47	1.900	31	VN7+(VN6-VN7)*1008/3300
30H	VN48	1.908	25	VN7+(VN6-VN7)*1104/3300
31H	VN49	1.915	25	VN7+(VN6-VN7)*1188/3300
32H	VN50	1.921	25	VN7+(VN6-VN7)*1260/3300
33H	VN51	1.928	25	VN7+(VN6-VN7)*1344/3300
34H	VN52	1.934	31	VN7+(VN6-VN7)*1416/3300

Data	Negative Polarity Gray Level	Voltage	Ohm	Formula
35H	VN53	1.942	31	$VN7+(VN6-VN7)*1512/3300$
36H	VN54	1.95	31	$VN7+(VN6-VN7)*1608/3300$
37H	VN55	1.958	31	$VN7+(VN6-VN7)*1704/3300$
38H	VN56	1.966	28	$VN7+(VN6-VN7)*1800/3300$
39H	VN57	1.973	28	$VN7+(VN6-VN7)*1884/3300$
3AH	VN58	1.981	28	$VN7+(VN6-VN7)*1980/3300$
3BH	VN59	1.988	28	$VN7+(VN6-VN7)*2064/3300$
3CH	VN60	1.995	24	$VN7+(VN6-VN7)*2148/3300$
3DH	VN61	2.001	24	$VN7+(VN6-VN7)*2220/3300$
3EH	VN62	2.008	24	$VN7+(VN6-VN7)*2304/3300$
3FH	VN63	2.014	24	$VN7+(VN6-VN7)*2376/3300$
40H	VN64	2.02	22	$VN7+(VN6-VN7)*2448/3300$
41H	VN65	2.026	22	$VN7+(VN6-VN7)*2520/3300$
42H	VN66	2.032	22	$VN7+(VN6-VN7)*2592/3300$
43H	VN67	2.037	22	$VN7+(VN6-VN7)*2652/3300$
44H	VN68	2.043	24	$VN7+(VN6-VN7)*2724/3300$
45H	VN69	2.049	24	$VN7+(VN6-VN7)*2796/3300$
46H	VN70	2.056	24	$VN7+(VN6-VN7)*2880/3300$
47H	VN71	2.062	24	$VN7+(VN6-VN7)*2952/3300$
48H	VN72	2.068	22	$VN7+(VN6-VN7)*3024/3300$
49H	VN73	2.074	22	$VN7+(VN6-VN7)*3096/3300$
4AH	VN74	2.08	22	$VN7+(VN6-VN7)*3168/3300$
4BH	VN75	2.085	22	$VN7+(VN6-VN7)*3228/3300$
4CH	VN76	2.091 (V6)	25	VN6
4DH	VN77	2.098	25	$VN6+(VN5-VN6)*84/2508$
4EH	VN68	2.104	25	$VN6+(VN5-VN6)*156/2508$
4FH	VN79	2.111	25	$VN6+(VN5-VN6)*240/2508$
50H	VN80	2.117	28	$VN6+(VN5-VN6)*312/2508$
51H	VN81	2.124	28	$VN6+(VN5-VN6)*396/2508$
52H	VN82	2.132	28	$VN6+(VN5-VN6)*492/2508$
53H	VN83	2.139	28	$VN6+(VN5-VN6)*576/2508$
54H	VN84	2.146	19	$VN6+(VN5-VN6)*660/2508$
55H	VN85	2.151	19	$VN6+(VN5-VN6)*720/2508$
56H	VN86	2.156	19	$VN6+(VN5-VN6)*780/2508$
57H	VN87	2.161	19	$VN6+(VN5-VN6)*840/2508$
58H	VN88	2.166	24	$VN6+(VN5-VN6)*900/2508$
59H	VN89	2.172	24	$VN6+(VN5-VN6)*972/2508$
5AH	VN90	2.179	24	$VN6+(VN5-VN6)*1056/2508$
5BH	VN91	2.185	24	$VN6+(VN5-VN6)*1128/2508$
5CH	VN92	2.191	26	$VN6+(VN5-VN6)*1200/2508$
5DH	VN93	2.198	26	$VN6+(VN5-VN6)*1284/2508$
5EH	VN94	2.205	26	$VN6+(VN5-VN6)*1368/2508$
5FH	VN95	2.211	26	$VN6+(VN5-VN6)*1440/2508$
60H	VN96	2.218	23	$VN6+(VN5-VN6)*1524/2508$
61H	VN97	2.224	23	$VN6+(VN5-VN6)*1596/2508$
62H	VN98	2.23	23	$VN6+(VN5-VN6)*1668/2508$
63H	VN99	2.236	23	$VN6+(VN5-VN6)*1740/2508$
64H	VN100	2.242	24	$VN6+(VN5-VN6)*1812/2508$
65H	VN101	2.248	24	$VN6+(VN5-VN6)*1884/2508$
66H	VN102	2.255	24	$VN6+(VN5-VN6)*1968/2508$
67H	VN103	2.261	24	$VN6+(VN5-VN6)*2040/2508$
68H	VN104	2.267	25	$VN6+(VN5-VN6)*2112/2508$
69H	VN105	2.274	25	$VN6+(VN5-VN6)*2196/2508$
6AH	VN106	2.28	25	$VN6+(VN5-VN6)*2268/2508$

Data	Negative Polarity Gray Level	Voltage	Ohm	Formula
6BH	VN107	2.287	25	$VN6+(VN5-VN6)*2352/2508$
6CH	VN108	2.293	27	$VN6+(VN5-VN6)*2424/2508$
6DH	VN109	2.300 (V5)	27	VN5
6EH	VN110	2.307	27	$VN5+(VN4-VN5)*84/2916$
6FH	VN111	2.314	27	$VN5+(VN4-VN5)*168/2916$
70H	VN112	2.321	23	$VN5+(VN4-VN5)*252/2916$
71H	VN113	2.327	23	$VN5+(VN4-VN5)*324/2916$
72H	VN114	2.332	23	$VN5+(VN4-VN5)*384/2916$
73H	VN115	2.338	23	$VN5+(VN4-VN5)*456/2916$
74H	VN116	2.343	24	$VN5+(VN4-VN5)*516/2916$
75H	VN117	2.349	24	$VN5+(VN4-VN5)*588/2916$
76H	VN118	2.355	24	$VN5+(VN4-VN5)*660/2916$
77H	VN119	2.361	24	$VN5+(VN4-VN5)*732/2916$
78H	VN120	2.367	25	$VN5+(VN4-VN5)*804/2916$
79H	VN121	2.375	25	$VN5+(VN4-VN5)*900/2916$
7AH	VN122	2.383	25	$VN5+(VN4-VN5)*996/2916$
7BH	VN123	2.39	25	$VN5+(VN4-VN5)*1080/2916$
7CH	VN124	2.398	27	$VN5+(VN4-VN5)*1176/2916$
7DH	VN125	2.405	27	$VN5+(VN4-VN5)*1260/2916$
7EH	VN126	2.412	27	$VN5+(VN4-VN5)*1344/2916$
7FH	VN127	2.419	27	$VN5+(VN4-VN5)*1428/2916$
80H	VN128	2.426	21	$VN5+(VN4-VN5)*1512/2916$
81H	VN129	2.433	26	$VN5+(VN4-VN5)*1596/2916$
82H	VN130	2.44	26	$VN5+(VN4-VN5)*1680/2916$
83H	VN131	2.446	26	$VN5+(VN4-VN5)*1752/2916$
84H	VN132	2.453	29	$VN5+(VN4-VN5)*1836/2916$
85H	VN133	2.461	29	$VN5+(VN4-VN5)*1932/2916$
86H	VN134	2.468	29	$VN5+(VN4-VN5)*2016/2916$
87H	VN135	2.476	29	$VN5+(VN4-VN5)*2112/2916$
88H	VN136	2.483	30	$VN5+(VN4-VN5)*2196/2916$
89H	VN137	2.491	30	$VN5+(VN4-VN5)*2292/2916$
8AH	VN138	2.499	30	$VN5+(VN4-VN5)*2388/2916$
8BH	VN139	2.506	30	$VN5+(VN4-VN5)*2472/2916$
8CH	VN140	2.514	28	$VN5+(VN4-VN5)*2568/2916$
8DH	VN141	2.521	28	$VN5+(VN4-VN5)*2652/2916$
8EH	VN142	2.529	28	$VN5+(VN4-VN5)*2748/2916$
8FH	VN143	2.536	28	$VN5+(VN4-VN5)*2832/2916$
90H	VN144	2.543 (V4)	27	VN4
91H	VN145	2.55	27	$VN4+(VN3-VN4)*84/3720$
92H	VN146	2.557	27	$VN4+(VN3-VN4)*168/3720$
93H	VN147	2.564	27	$VN4+(VN3-VN4)*252/3720$
94H	VN148	2.571	24	$VN4+(VN3-VN4)*336/3720$
95H	VN149	2.577	24	$VN4+(VN3-VN4)*408/3720$
96H	VN150	2.584	24	$VN4+(VN3-VN4)*492/3720$
97H	VN151	2.59	24	$VN4+(VN3-VN4)*564/3720$
98H	VN152	2.596	32	$VN4+(VN3-VN4)*636/3720$
99H	VN153	2.604	32	$VN4+(VN3-VN4)*732/3720$
9AH	VN154	2.613	32	$VN4+(VN3-VN4)*840/3720$
9BH	VN155	2.621	32	$VN4+(VN3-VN4)*936/3720$
9CH	VN156	2.629	37	$VN4+(VN3-VN4)*1032/3720$
9DH	VN157	2.639	38	$VN4+(VN3-VN4)*1152/3720$
9EH	VN158	2.649	37	$VN4+(VN3-VN4)*1272/3720$
9FH	VN159	2.658	37	$VN4+(VN3-VN4)*1380/3720$
A0H	VN160	2.668	40	$VN4+(VN3-VN4)*1500/3720$

Data	Negative Polarity Gray Level	Voltage	Ohm	Formula
A1H	VN161	2.679	40	$VN4+(VN3-VN4)*1632/3720$
A2H	VN162	2.689	40	$VN4+(VN3-VN4)*1752/3720$
A3H	VN163	2.7	40	$VN4+(VN3-VN4)*1884/3720$
A4H	VN164	2.71	35	$VN4+(VN3-VN4)*2004/3720$
A5H	VN165	2.719	35	$VN4+(VN3-VN4)*2112/3720$
A6H	VN166	2.728	35	$VN4+(VN3-VN4)*2220/3720$
A7H	VN167	2.737	35	$VN4+(VN3-VN4)*2328/3720$
A8H	VN168	2.746	25	$VN4+(VN3-VN4)*2436/3720$
A9H	VN169	2.753	25	$VN4+(VN3-VN4)*2520/3720$
AAH	VN170	2.759	25	$VN4+(VN3-VN4)*2592/3720$
ABH	VN171	2.766	25	$VN4+(VN3-VN4)*2676/3720$
ACH	VN172	2.772	26	$VN4+(VN3-VN4)*2748/3720$
ADH	VN173	2.779	26	$VN4+(VN3-VN4)*2832/3720$
AEH	VN174	2.786	26	$VN4+(VN3-VN4)*2916/3720$
AFH	VN175	2.792	26	$VN4+(VN3-VN4)*2988/3720$
B0H	VN176	2.799	42	$VN4+(VN3-VN4)*3072/3720$
B1H	VN177	2.81	42	$VN4+(VN3-VN4)*3204/3720$
B2H	VN178	2.821	42	$VN4+(VN3-VN4)*3336/3720$
B3H	VN179	2.832	42	$VN4+(VN3-VN4)*3468/3720$
B4H	VN180	2.843	39	$VN4+(VN3-VN4)*3600/3720$
B5H	VN181	2.853 (V3)	39	VN3
B6H	VN182	2.868	39	$VN3+(VN2-VN3)*132/5252$
B7H	VN183	2.881	39	$VN3+(VN2-VN3)*252/5252$
B8H	VN184	2.894	34	$VN3+(VN2-VN3)*372/5252$
B9H	VN185	2.906	34	$VN3+(VN2-VN3)*480/5252$
BAH	VN186	2.918	34	$VN3+(VN2-VN3)*588/5252$
BBH	VN187	2.929	34	$VN3+(VN2-VN3)*684/5252$
BCH	VN188	2.941	33	$VN3+(VN2-VN3)*792/5252$
BDH	VN189	2.953	33	$VN3+(VN2-VN3)*900/5252$
BEH	VN190	2.963	33	$VN3+(VN2-VN3)*996/5252$
BFH	VN191	2.975	33	$VN3+(VN2-VN3)*1104/5252$
C0H	VN192	2.986	48	$VN3+(VN2-VN3)*1200/5252$
C1H	VN193	3.003	48	$VN3+(VN2-VN3)*1356/5252$
C2H	VN194	3.019	48	$VN3+(VN2-VN3)*1500/5252$
C3H	VN195	3.037	48	$VN3+(VN2-VN3)*1656/5252$
C4H	VN196	3.052	48	$VN3+(VN2-VN3)*1800/5252$
C5H	VN197	3.070	48	$VN3+(VN2-VN3)*1956/5252$
C6H	VN198	3.086	48	$VN3+(VN2-VN3)*2100/5252$
C7H	VN199	3.103	48	$VN3+(VN2-VN3)*2256/5252$
C8H	VN200	3.119	48	$VN3+(VN2-VN3)*2400/5252$
C9H	VN201	3.136	48	$VN3+(VN2-VN3)*2556/5252$
CAH	VN202	3.152	48	$VN3+(VN2-VN3)*2700/5252$
CBH	VN203	3.169	48	$VN3+(VN2-VN3)*2856/5252$
CCH	VN204	3.185	62	$VN3+(VN2-VN3)*3000/5252$
CDH	VN205	3.207	63	$VN3+(VN2-VN3)*3192/5252$
CEH	VN206	3.229	62	$VN3+(VN2-VN3)*3396/5252$
CFH	VN207	3.251	62	$VN3+(VN2-VN3)*3588/5252$
D0H	VN208	3.272	54	$VN3+(VN2-VN3)*3780/5252$
D1H	VN209	3.291	54	$VN3+(VN2-VN3)*3954/5252$
D2H	VN210	3.301	54	$VN3+(VN2-VN3)*4041/5252$
D3H	VN211	3.310	54	$VN3+(VN2-VN3)*4128/5252$
D4H	VN212	3.320	57	$VN3+(VN2-VN3)*4216/5252$
D5H	VN213	3.330	57	$VN3+(VN2-VN3)*4304/5252$
D6H	VN214	3.340	57	$VN3+(VN2-VN3)*4393/5252$

Data	Negative Polarity Gray Level	Voltage	Ohm	Formula
D7H	VN215	3.350	57	$VN3+(VN2-VN3)*4482/5252$
D8H	VN216	3.360	75	$VN3+(VN2-VN3)*4575/5252$
D9H	VN217	3.371	75	$VN3+(VN2-VN3)*4670/5252$
DAH	VN218	3.381	75	$VN3+(VN2-VN3)*4766/5252$
DBH	VN219	3.392	75	$VN3+(VN2-VN3)*4862/5252$
DCH	VN220	3.403	94	$VN3+(VN2-VN3)*4959/5252$
DDH	VN221	3.413	94	$VN3+(VN2-VN3)*5056/5252$
DEH	VN222	3.424	94	$VN3+(VN2-VN3)*5154/5252$
DFH	VN223	3.435 (V2)	94	VN2
E0H	VN224	3.442	87	$VN2+(VN1-VN2)*99/13910$
E1H	VN225	3.450	88	$VN2+(VN1-VN2)*199/13910$
E2H	VN226	3.457	87	$VN2+(VN1-VN2)*299/13910$
E3H	VN227	3.464	87	$VN2+(VN1-VN2)*400/13910$
E4H	VN228	3.473	90	$VN2+(VN1-VN2)*519/13910$
E5H	VN229	3.482	90	$VN2+(VN1-VN2)*645/13910$
E6H	VN230	3.491	90	$VN2+(VN1-VN2)*772/13910$
E7H	VN231	3.501	90	$VN2+(VN1-VN2)*900/13910$
E8H	VN232	3.510	115	$VN2+(VN1-VN2)*1028/13910$
E9H	VN233	3.519	115	$VN2+(VN1-VN2)*1157/13910$
EAH	VN234	3.529	115	$VN2+(VN1-VN2)*1287/13910$
EBH	VN235	3.538	115	$VN2+(VN1-VN2)*1417/13910$
ECH	VN236	3.548	148	$VN2+(VN1-VN2)*1548/13910$
EDH	VN237	3.559	148	$VN2+(VN1-VN2)*1700/13910$
EEH	VN238	3.571	148	$VN2+(VN1-VN2)*1864/13910$
EFH	VN239	3.583	148	$VN2+(VN1-VN2)*2029/13910$
F0H	VN240	3.595	183	$VN2+(VN1-VN2)*2194/13910$
F1H	VN241	3.607	183	$VN2+(VN1-VN2)*2360/13910$
F2H	VN242	3.619	183	$VN2+(VN1-VN2)*2527/13910$
F3H	VN243	3.632	183	$VN2+(VN1-VN2)*2695/13910$
F4H	VN244	3.648	148	$VN2+(VN1-VN2)*2913/13910$
F5H	VN245	3.666	148	$VN2+(VN1-VN2)*3164/13910$
F6H	VN246	3.684	148	$VN2+(VN1-VN2)*3416/13910$
F7H	VN247	3.703	148	$VN2+(VN1-VN2)*3670/13910$
F8H	VN248	3.721	128	$VN2+(VN1-VN2)*3925/13910$
F9H	VN249	3.751	128	$VN2+(VN1-VN2)*4335/13910$
FAH	VN250	3.782	128	$VN2+(VN1-VN2)*4750/13910$
FBH	VN251	3.814	128	$VN2+(VN1-VN2)*5194/13910$
FCH	VN252	3.857	71	$VN2+(VN1-VN2)*5779/13910$
FDH	VN253	3.909	71	$VN2+(VN1-VN2)*6490/13910$
FEH	VN254	4.050	71	$VN2+(VN1-VN2)*8434/13910$
FFH	VN255	4.450 (V1)		VN1

If the default VREG1OUT(V0) ≠ 4.5V, you can refer to following the formula to calculate voltage (V1~V8):

	Positive voltage	Negative voltage	Positive voltage	Negative voltage
V1	4.45	4.45	$(V0) * 4.45 / 4.5$	$(V0) * 4.45 / 4.5$
V2	3.43	3.43	$(V0) * 3.43 / 4.5$	$(V0) * 3.43 / 4.5$
V3	2.85	2.85	$(V0) * 2.85 / 4.5$	$(V0) * 2.85 / 4.5$
V4	2.54	2.54	$(V0) * 2.54 / 4.5$	$(V0) * 2.54 / 4.5$
V5	2.30	2.30	$(V0) * 2.30 / 4.5$	$(V0) * 2.30 / 4.5$
V6	2.09	2.09	$(V0) * 2.09 / 4.5$	$(V0) * 2.09 / 4.5$
V7	1.82	1.82	$(V0) * 1.82 / 4.5$	$(V0) * 1.82 / 4.5$
V8	0.5	0.5	$(V0) * 0.5 / 4.5$	$(V0) * 0.5 / 4.5$

10. Power Sequence

10.1. Power ON Sequence

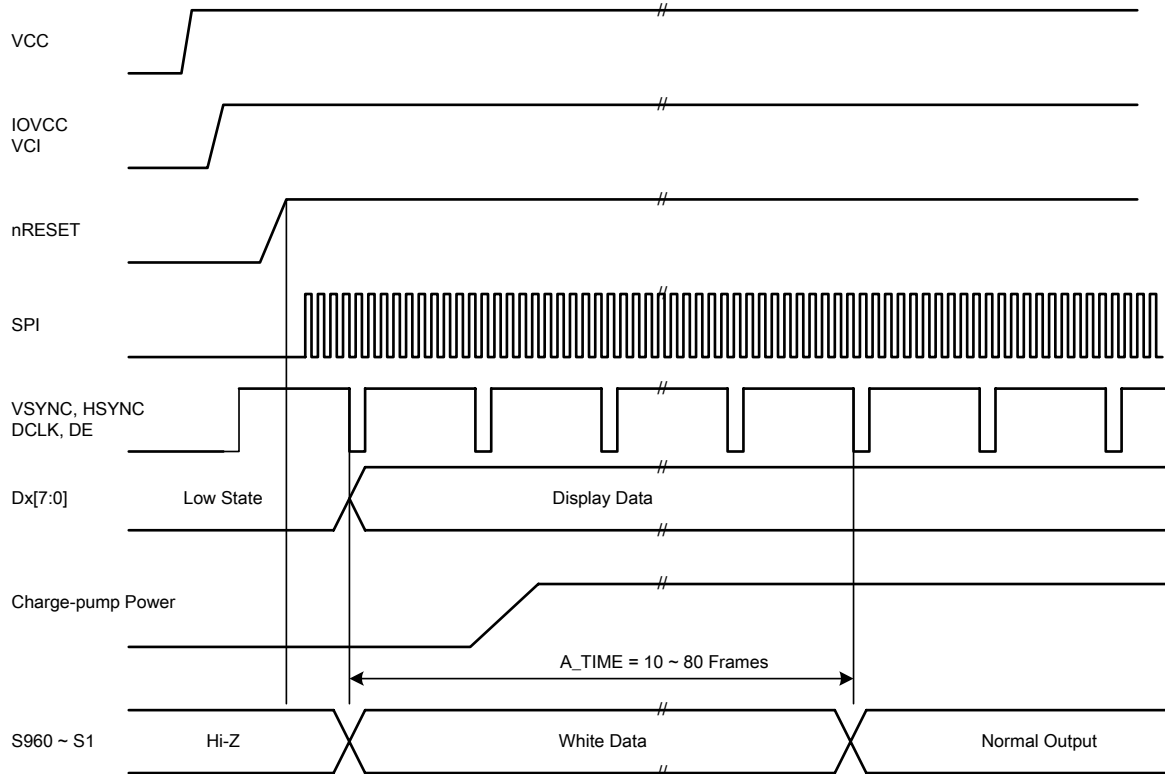

Figure8 Power On Sequence

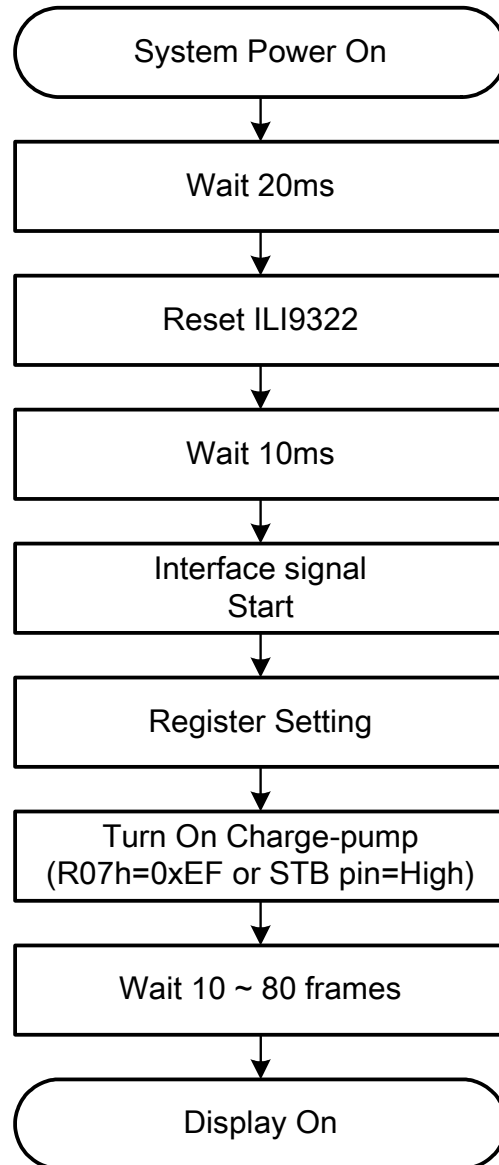

Figure9 Power On Sequence Flow Chart

10.2. Power OFF Sequence

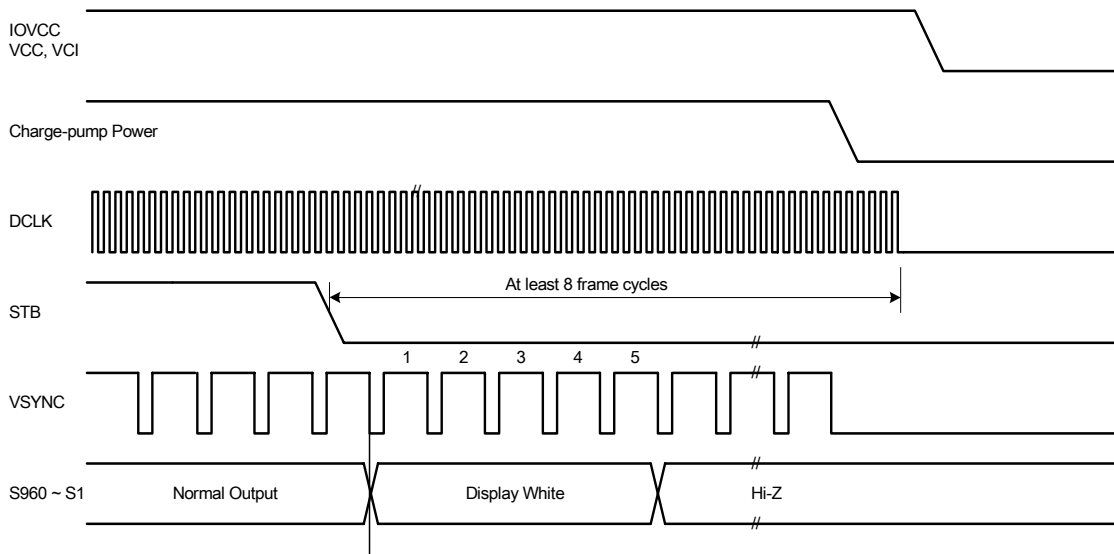

Figure 10 Power Off Sequence Flow Chart

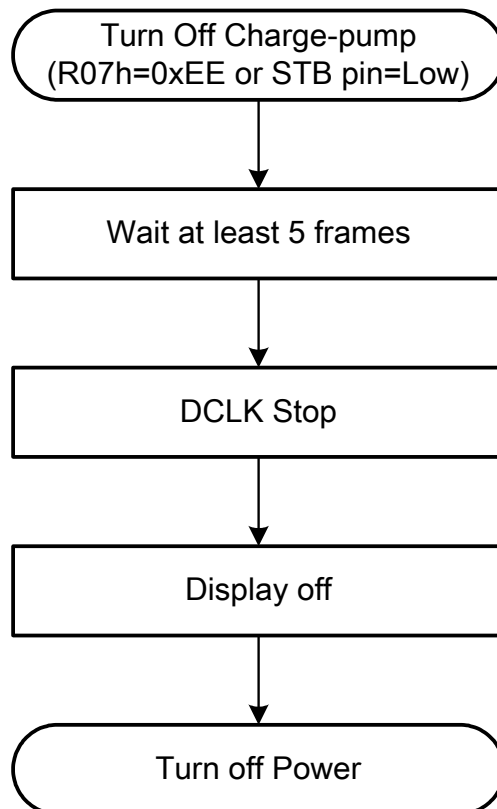

Figure11 Power Off Sequence Flow Chart

10.3. Standby Sequence

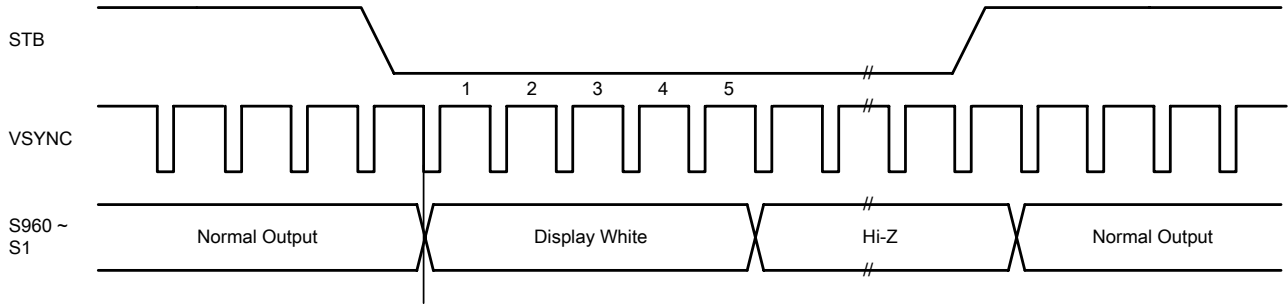

Figure12 Standby On/Off Sequence

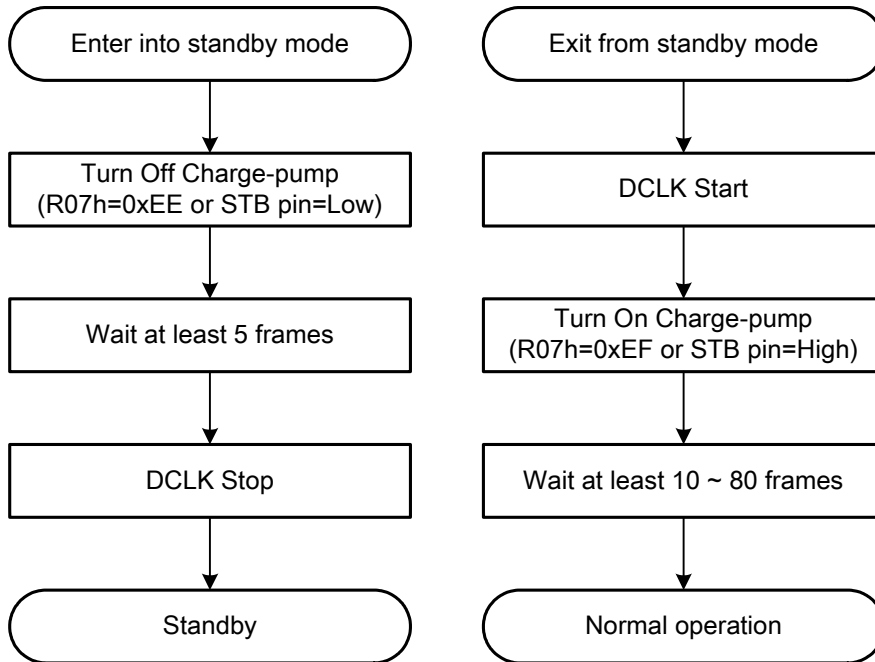

Figure13 Standby On/Off Flow Chart

11. Electrical Characteristics

11.1. Absolute Maximum Ratings

Items	Symbol	Condition	Min.	Max.	Unit	Note
Power Voltage	VCC	GND=0	-0.3	4.6	Volt	
	VCI	AGND=0	-0.3	4.6	Volt	
	IOVCC	GND=0	-0.3	4.6	Volt	
Operation Temperature	Topa	-	-40	85	°C	Ambient temperature
Storage Temperature	Tstg	-	-55	125	°C	Ambient temperature

Note:

- (1) All the voltages listed above are with respect to GND=0V.
- (2) Device is subject to be damaged permanently if stresses beyond those absolute maximum ratings listed above.

11.2. DC Electrical Characteristics

Typical Operating Conditions

Items	Symbol	Min.	Typ.	Max.	Unit	Note
Power voltage	VCC	2.7	3.3	3.6	Volt	
	Vci	2.7	3.3	3.6	Volt	
	IOVcc	1.65	3.3	3.6	Volt	
Output signal high voltage	V _{OH}	0.8*IOVcc	-	IOVCC	Volt	
Output signal low voltage	V _{OL}	GND	-	0.2*IOVcc	Volt	
Input signal high voltage	V _{IH}	0.7*IOVc	-	IOVcc	Volt	
Input signal low voltage	V _{IL}	GND	-	0.3*IOVcc	Volt	
Input leakage current	I _{IN}	-1	-	1	uA	
Digital standby current	I _{ST}	-	10	50	uA	DCLK stop and inputs are default
Digital operating current	I _{CC}	-	TBD	TBD	mA	DCLK=25MHz, VCC=3.3V
Pull high/low resistor	R _P	150K	200K	300K	ohm	Digital input pads

12. Revision History

Version No.	Date	Page	Description
V0.8	2007/3/2		Modify the source/gate pad size (120x18um → 100 x 18um).
V1.0	2007/4/10	43	Modify the OTP programming flow
V1.1	2007/5/15	47~61	Modify and update the default Gamma value